

Veri sayfası | Ürün numarası: 2857-534
JUMPFLEX® transdüser; TC eşik değer anahtarı

www.wago.com/2857-534

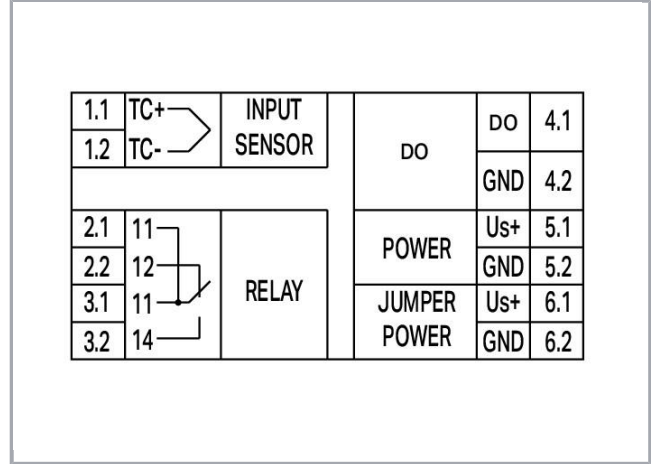
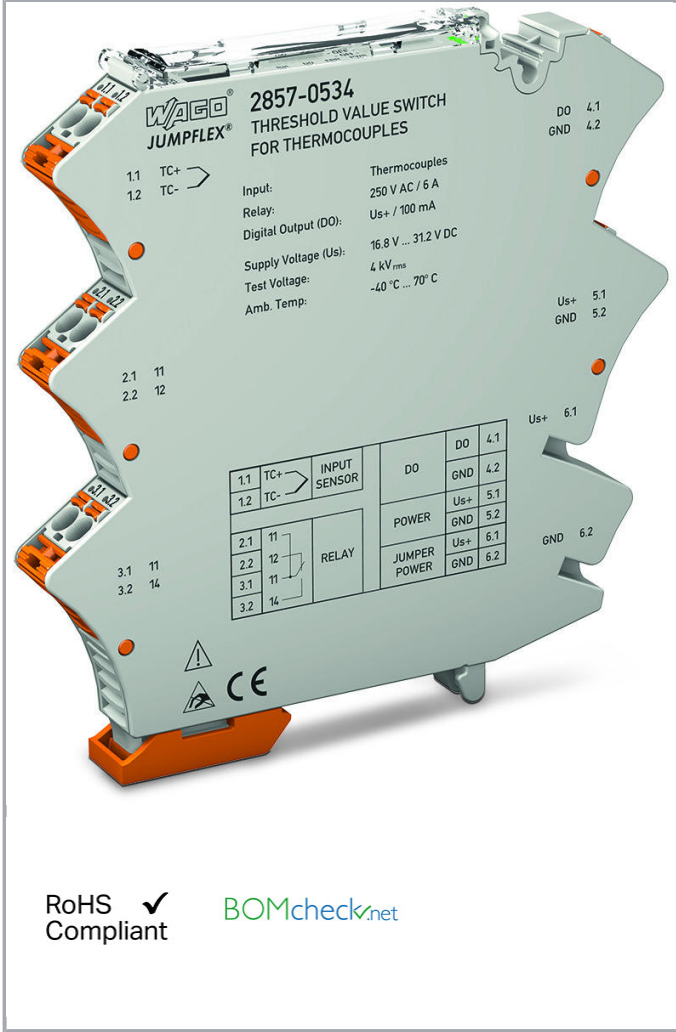

Değişikliklere tabidir.

WAGO Elektronik Sanayi ve Ticaret Ltd. Şti.
Yukarı Dudullu Mahallesi Bayraktar Bulvarı
Cad. Hattat Sok. No. 10 | 34775 Ümraniye - İstanbul
Tel.: +90 216 472 1133 111 | Fax: +90 216 472 9910
Email: info.tr@wago.com

Ürünlerimizle ilgili sorularınız mı var?
+90 216 472 1133 numaralı telefondan sizinle konuşmaktan mutluluk
duyarız.

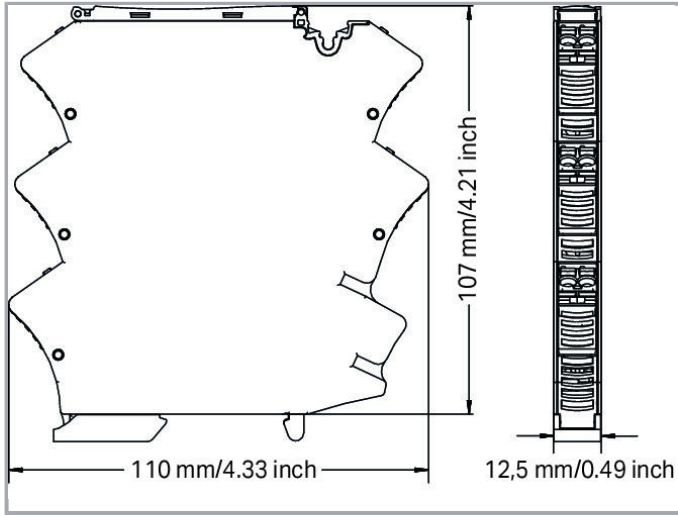

2857-534
DIP Switch Adjustability

• = ON Default

DIP Switch S1

Sensor Type				Cold Junction Compensation		Hysteresis		Rise/Fall Delay Relay/DO			
1	2	3	4	5	6	T/K	7	8	9	10	Reserve
•	•	•	•	J	ON	3	•	•	•	•	0
•	•	•	•	K	OFF	5	•	•	•	•	1
•	•	•	•	E			•	•	•	•	2
•	•	•	•	R			•	•	•	•	3
•	•	•	•	N			•	•	•	•	4
•	•	•	•	S			•	•	•	•	5
•	•	•	•	T			•	•	•	•	8
•	•	•	•	B			•	•	•	•	10
•	•	•	•	C			•	•	•	•	

DIP Switch S2

Start Value					End Value				
1	2	3	4	5	6	7	8	9	10
				Temperature / °C					Temperature / °C
•	•	•	•	0	•	•	•	•	100
•	•	•	•	OFF	•	•	•	•	OFF
•	•	•	•	-200	•	•	•	•	-200
•	•	•	•	-150	•	•	•	•	-150
•	•	•	•	-100	•	•	•	•	-100
•	•	•	•	-50	•	•	•	•	-50
•	•	•	•	50	•	•	•	•	50
•	•	•	•	100	•	•	•	•	100
•	•	•	•	150	•	•	•	•	150
•	•	•	•	200	•	•	•	•	200
•	•	•	•	250	•	•	•	•	250
•	•	•	•	300	•	•	•	•	300
•	•	•	•	350	•	•	•	•	350
•	•	•	•	400	•	•	•	•	400
•	•	•	•	450	•	•	•	•	450
•	•	•	•	500	•	•	•	•	500
•	•	•	•	550	•	•	•	•	550
•	•	•	•	600	•	•	•	•	600
•	•	•	•	650	•	•	•	•	650
•	•	•	•	700	•	•	•	•	700
•	•	•	•	750	•	•	•	•	750
•	•	•	•	800	•	•	•	•	800
•	•	•	•	850	•	•	•	•	850
•	•	•	•	900	•	•	•	•	900
•	•	•	•	950	•	•	•	•	950
•	•	•	•	1000	•	•	•	•	1000
•	•	•	•	1050	•	•	•	•	1050
•	•	•	•	1100	•	•	•	•	1100
•	•	•	•	1150	•	•	•	•	1150
•	•	•	•	1200	•	•	•	•	1200
•	•	•	•	1300	•	•	•	•	1300
•	•	•	•	1400	•	•	•	•	1400

Ürün tanımı

Kısa tanımı:

TC sensörleri için WAGO'nun Termokupl Eşik Değer Anahtarı ikiye kadar anahtarlama eşiği sinyallerini izler ve rapor eder.

Özellikler:

- Hem dijital sinyal çıkışı hem de değişken kontaklı röle ayarlanmış ölçüm aralığı sınırlarına reaksiyon gösterir (Açma/Kapama gecikmesi ve ikiye kadar eşik değerle ayarlanabilen eşik değer anahtarlama fonksiyonu)
- Ayarlanabilir yazılım filtresi
- Konfigürasyon ekranı üzerinden Giriş/Çıkış tepki simülasyonu
- EN 61140'a uygun 4 kV test gerilimiyle güvenli, 3 yollu yalıtım

Note:

Additional setting options via interface configuration software/app

Veri

Technical Data

Değişikliklere tabidir.

WAGO Elektronik Sanayi ve Ticaret Ltd. Şti.
Yukarı Dudullu Mahallesi Bayraktar Bulvarı
Cad. Hattat Sok. No. 10 | 34775 Ümraniye - İstanbul
Tel.: +90 216 472 1133 111 | Fax: +90 216 472 9910
Email: info.tr@wago.com

Ürünlerimizle ilgili sorularınız mı var?

+90 216 472 1133 numaralı telefondan sizinle konuşmaktan mutluluk duyuyoruz.



Configuration

Configuration options

DIP switches
Interface configuration software
Interface configuration app
Configuration display

Input

Input signal type

TC sensors

Input – TC sensors

Sensor types (TC)

Type J
Type K
Type E
Type N
Type R
Type S
Type T
Type B
Type C

Measurement range temperature (TC)

-210 ... 1200 °C (Type J); -200 ... 1372 °C (Type K)

Soğuk bağlantı(cold junction) kompanzasyonu

Açık/Kapalı (Fabrika Ayarı: Açık)

Cold Junction hatası

3 K (tip. 2 K)

Çıkış – Dijital:

Max. switching voltage (DO)

Uygulanan besleme gerilimi: -0,3 V

Max. continuous current (DO)

100 mA (no internal restriction)

Number of switching thresholds (DO)

1 or 2 (adjustable)

Configurable rise/fall delay time (DO)

0 ... 60 s (via software)

Çıkış – Röle:

Dielektrik dayanımı, açık kontak (AC, 1 dak)

1 kV_{rms}

Number of changeover/switchover contacts

1

Contact material (relay)

AgNi + Au

Max. switching voltage

AC 250 V

Limiting continuous current (relay; terminal block assembly)

6 A (6 A (60 °C'ye kadar), 3 A (60 °C ... 70 °C)); 3 A (60 ... 70 °C)

Dielectric strength open contact (AC, 1 min)

1 kVrms

Çekme süresi (tip.)

8 ms

Değişikliklere tabidir.



Bırakma süresi	4 ms
Sıçrama süresi (tip.)	8 ms
Number of switching thresholds (relay)	1 or 2 (adjustable)
Configurable rise/fall delay time (relay)	0 ... 60 s (via software)

Signal processing

Filtre (T_{10-90})	moving mean value (filtering level: 30)
Hysteresis	adjustable via DIP switch or software
Step response typ.	60 ms (cold junction compensation off); 360 ms (cold junction compensation on)

Measurement error

İletim hatası (tam skala)	± 1 K
Sıcaklık katsayısı	$\leq \%0,01 /K$

Power supply

Type of power supply	24 VDC
Nominal supply voltage U_S	DC 24 V
Supply voltage range	± 30 %
Current consumption at supply voltage	≤ 40 mA (+ I_{D0})

Safety and protection:

Test voltage (input/output/supply)	AC 4 kV; 50 Hz; 1 min
Koruma sınıfı	IP20

Bağlantı verisi

Bağlantı teknolojisi	CAGE CLAMP® S
WAGO terminal	picoMAX® 5.0
Tek damarlı boylar	0,2 ... 2,5 mm ² / 24 ... 12 AWG
İnce bükümlü kablolar	0,2 ... 2,5 mm ² / 24 ... 12 AWG
Sıyırma uzunluğu	9 ... 10 mm / 0.35 ... 0.39 inch

Geometrical Data

Width	12,5 mm / 0.492 inch
-------	----------------------

Değişikliklere tabidir.

WAGO Elektronik Sanayi ve Ticaret Ltd. Şti.
Yukarı Dudullu Mahallesi Bayraktar Bulvarı
Cad. Hattat Sok. No. 10 | 34775 Ümraniye - İstanbul
Tel.: +90 216 472 1133 111 | Fax: +90 216 472 9910
Email: info.tr@wago.com

Ürünlerimizle ilgili sorularınız mı var?
+90 216 472 1133 numaralı telefondan sizinle konuşmaktan mutluluk
duyarız.



DIN rayın üst kenarından yükseklik	107 mm / 4.213 inch
Depth	110 mm / 4.331 inch

Mekanik Veri

Montaj tipi	DIN 35 ray
-------------	------------

Material Data

Ağırlık	105,8 g
---------	---------

Environmental Requirements

Surrounding air (operating) temperature	-40 ... 70 °C
Surrounding air (storage) temperature	-40 ... 85 °C
Temperaturbereich der Anschlussleitung gemäß UL 61010-2-201 min.	90 °C

Standartlar ve Spesifikasyonlar:

Uygunluk işareti	CE
EMC immunity to interference	EN 61000-6-2; EN 61326-2-3; EN 50121-3-2
EMU: 1 - enterferans emisyonu	EN 61000-6-4; EN 61326-2-3; EN 50121-3-2
Standartlar/spesifikasyonlar	EN 61010-1; EN 61373

Ticari Veri

SAP'den ambalaj tipi	bag
Country of origin	DE
GTIN	4055143242318
Customs Tariff No.	90303370000

Counterpart













Uyumlu ürünler

Değişikliklere tabidir.

WAGO Elektronik Sanayi ve Ticaret Ltd. Şti.
Yukarı Dudullu Mahallesi Bayraktar Bulvarı
Cad. Hattat Sok. No. 10 | 34775 Ümraniye - İstanbul
Tel.: +90 216 472 1133 111 | Fax: +90 216 472 9910
Email: info.tr@wago.com

Ürünlerimizle ilgili sorularınız mı var?
+90 216 472 1133 numaralı telefondan sizinle konuşmaktan mutluluk duyarız.















Marking accessories

	Ürün no.: 2009-110 Marking strips; on reel; not stretchable; plain; snap-on type; white	www.wago.com/2009-110
	Ürün no.: 2009-115 WMB-Inline; Smart Printer için; makarada; uzatılabilir 5 - 5,2 mm; düz; takma tipi; beyaz	www.wago.com/2009-115
	Ürün no.: 2009-115/000-002 WMB-Inline; for Smart Printer; 1500 pieces on roll; stretchable 5 - 5.2 mm; plain; snap-on type; yellow	www.wago.com/2009-115/000-002
	Ürün no.: 2009-115/000-006 WMB-Inline; for Smart Printer; 1500 pieces on roll; stretchable 5 - 5.2 mm; plain; snap-on type; white	www.wago.com/2009-115/000-006
	Ürün no.: 2009-115/000-007 WMB-Inline; for Smart Printer; 1500 pieces on roll; stretchable 5 - 5.2 mm; plain; snap-on type; gray	www.wago.com/2009-115/000-007
	Ürün no.: 2009-115/000-012 WMB-Inline; Smart Printer için; makarada; uzatılabilir 5 - 5,2 mm; düz; takma tipi; turuncu	www.wago.com/2009-115/000-012
	Ürün no.: 2009-115/000-017 WMB-Inline; for Smart Printer; 1500 pieces on roll; stretchable 5 - 5.2 mm; plain; snap-on type; white	www.wago.com/2009-115/000-017
	Ürün no.: 2009-115/000-023 WMB-Inline; for Smart Printer; 1500 pieces on roll; stretchable 5 - 5.2 mm; plain; snap-on type; green	www.wago.com/2009-115/000-023
	Ürün no.: 2009-115/000-024 WMB-Inline; for Smart Printer; 1500 pieces on roll; stretchable 5 - 5.2 mm; plain; snap-on type; white	www.wago.com/2009-115/000-024
	Ürün no.: 2009-141 Micro-WSB-Inline; makarada; düz; takma tipi; beyaz	www.wago.com/2009-141
	Ürün no.: 793-501 WMB etiket kartı; kart şeklinde; not stretchable; düz; takma tipi; beyaz	www.wago.com/793-501
	Ürün no.: 793-501/000-002 WMB etiket kartı; kart şeklinde; not stretchable; düz; takma tipi; sarı	www.wago.com/793-501/000-002
	Ürün no.: 793-501/000-005 WMB marking card; as card; not stretchable; plain; snap-on type; red	www.wago.com/793-501/000-005
	Ürün no.: 793-501/000-006 WMB etiket kartı; kart şeklinde; not stretchable; düz; takma tipi; mavi	www.wago.com/793-501/000-006

Değişikliklere tabidir.

WAGO Elektronik Sanayi ve Ticaret Ltd. Şti.
Yukarı Dudullu Mahallesi Bayraktar Bulvarı
Cad. Hattat Sok. No. 10 | 34775 Ümraniye - İstanbul
Tel.: +90 216 472 1133 111 | Fax: +90 216 472 9910
Email: info.tr@wago.com













Ürünlerimizle ilgili sorularınız mı var?
+90 216 472 1133 numaralı telefondan sizinle konuşmaktan mutluluk
duyarız.

	Ürün no.: 793-501/000-007 WMB etiket kartı; kart şeklinde; not stretchable; düz; takma tipi; gri	www.wago.com/793-501/000-007
	Ürün no.: 793-501/000-012 WMB etiket kartı; kart şeklinde; not stretchable; düz; takma tipi; turuncu	www.wago.com/793-501/000-012
	Ürün no.: 793-501/000-017 WMB etiket kartı; kart şeklinde; not stretchable; düz; takma tipi; açık yeşil	www.wago.com/793-501/000-017
	Ürün no.: 793-501/000-023 WMB etiket kartı; kart şeklinde; not stretchable; düz; takma tipi; yeşil	www.wago.com/793-501/000-023
	Ürün no.: 793-501/000-024 WMB etiket kartı; kart şeklinde; not stretchable; düz; takma tipi; menekşe	www.wago.com/793-501/000-024
	Ürün no.: 793-502 WMB etiket kartı; kart şeklinde; ETİKETLİ; 1 ... 10 (10x); not stretchable; Yatay etiketleme; takma tipi; beyaz	www.wago.com/793-502
	Ürün no.: 793-502/000-002 WMB etiket kartı; kart şeklinde; ETİKETLİ; 1 ... 10 (10x); not stretchable; Yatay etiketleme; takma tipi; sarı	www.wago.com/793-502/000-002
	Ürün no.: 793-502/000-005 WMB etiket kartı; kart şeklinde; ETİKETLİ; 1 ... 10 (10x); not stretchable; Yatay etiketleme; takma tipi; kırmızı	www.wago.com/793-502/000-005
	Ürün no.: 793-502/000-006 WMB etiket kartı; kart şeklinde; ETİKETLİ; 1 ... 10 (10x); not stretchable; Yatay etiketleme; takma tipi; mavi	www.wago.com/793-502/000-006
	Ürün no.: 793-502/000-007 WMB etiket kartı; kart şeklinde; ETİKETLİ; 1 ... 10 (10x); not stretchable; Yatay etiketleme; takma tipi; gri	www.wago.com/793-502/000-007
	Ürün no.: 793-502/000-012 WMB etiket kartı; kart şeklinde; ETİKETLİ; 1 ... 10 (10x); not stretchable; Yatay etiketleme; takma tipi; turuncu	www.wago.com/793-502/000-012
	Ürün no.: 793-502/000-017 WMB etiket kartı; kart şeklinde; ETİKETLİ; 1 ... 10 (10x); not stretchable; Yatay etiketleme; takma tipi; açık yeşil	www.wago.com/793-502/000-017
	Ürün no.: 793-502/000-023 WMB etiket kartı; kart şeklinde; ETİKETLİ; 1 ... 10 (10x); not stretchable; Yatay etiketleme; takma tipi; yeşil	www.wago.com/793-502/000-023
	Ürün no.: 793-502/000-024 WMB etiket kartı; kart şeklinde; ETİKETLİ; 1 ... 10 (10x); not stretchable; Yatay etiketleme; takma tipi;	www.wago.com/793-502/000-024















Değişikliklere tabidir.

WAGO Elektronik Sanayi ve Ticaret Ltd. Şti.
Yukarı Dudullu Mahallesi Bayraktar Bulvarı
Cad. Hattat Sok. No. 10 | 34775 Ümraniye - İstanbul
Tel.: +90 216 472 1133 111 | Fax: +90 216 472 9910
Email: info.tr@wago.com















Ürünlerimizle ilgili sorularınız mı var?
+90 216 472 1133 numaralı telefondan sizinle konuşmaktan mutluluk
duyarız.

	menekşe	
	Ürün no.: 793-503 WMB etiket kartı; kart şeklinde; ETİKETLİ; 11 ... 20 (10x); not stretchable; Yatay etiketleme; takma tipi; beyaz	www.wago.com/793-503
	Ürün no.: 793-503/000-002 WMB etiket kartı; kart şeklinde; ETİKETLİ; 11 ... 20 (10x); not stretchable; Yatay etiketleme; takma tipi; sarı	www.wago.com/793-503/000-002
	Ürün no.: 793-503/000-005 WMB etiket kartı; kart şeklinde; ETİKETLİ; 11 ... 20 (10x); not stretchable; Yatay etiketleme; takma tipi; kırmızı	www.wago.com/793-503/000-005
	Ürün no.: 793-503/000-006 WMB etiket kartı; kart şeklinde; ETİKETLİ; 11 ... 20 (10x); not stretchable; Yatay etiketleme; takma tipi; mavi	www.wago.com/793-503/000-006
	Ürün no.: 793-503/000-007 WMB etiket kartı; kart şeklinde; ETİKETLİ; 11 ... 20 (10x); not stretchable; Yatay etiketleme; takma tipi; gri	www.wago.com/793-503/000-007
	Ürün no.: 793-503/000-012 WMB etiket kartı; kart şeklinde; ETİKETLİ; 11 ... 20 (10x); not stretchable; Yatay etiketleme; takma tipi; turuncu	www.wago.com/793-503/000-012
	Ürün no.: 793-503/000-017 WMB etiket kartı; kart şeklinde; ETİKETLİ; 11 ... 20 (10x); not stretchable; Yatay etiketleme; takma tipi; açık yeşil	www.wago.com/793-503/000-017
	Ürün no.: 793-503/000-023 WMB etiket kartı; kart şeklinde; ETİKETLİ; 11 ... 20 (10x); not stretchable; Yatay etiketleme; takma tipi; yeşil	www.wago.com/793-503/000-023
	Ürün no.: 793-503/000-024 WMB etiket kartı; kart şeklinde; ETİKETLİ; 11 ... 20 (10x); not stretchable; Yatay etiketleme; takma tipi; menekşe	www.wago.com/793-503/000-024
	Ürün no.: 793-504 WMB marking card; as card; MARKED; 21 ... 30 (10x); not stretchable; Horizontal marking; snap-on type; white	www.wago.com/793-504
	Ürün no.: 793-504/000-002 WMB etiket kartı; kart şeklinde; ETİKETLİ; 21 ... 30 (10x); not stretchable; Yatay etiketleme; takma tipi; sarı	www.wago.com/793-504/000-002
	Ürün no.: 793-504/000-005 WMB etiket kartı; kart şeklinde; ETİKETLİ; 21 ... 30 (10x); not stretchable; Yatay etiketleme; takma tipi; kırmızı	www.wago.com/793-504/000-005
	Ürün no.: 793-504/000-006 WMB etiket kartı; kart şeklinde; ETİKETLİ; 21 ... 30 (10x); not stretchable; Yatay etiketleme; takma tipi; mavi	www.wago.com/793-504/000-006
	Ürün no.: 793-504/000-012	















Değişikliklere tabidir.

	WMB etiket kartı; kart şeklinde; ETİKETLİ; 21 ... 30 (10x); not stretchable; Yatay etiketleme; takma tipi; turuncu	www.wago.com/793-504/000-012
	Ürün no.: 793-504/000-017 WMB etiket kartı; kart şeklinde; ETİKETLİ; 21 ... 30 (10x); not stretchable; Yatay etiketleme; takma tipi; açık yeşil	www.wago.com/793-504/000-017
	Ürün no.: 793-504/000-023 WMB etiket kartı; kart şeklinde; ETİKETLİ; 21 ... 30 (10x); not stretchable; Yatay etiketleme; takma tipi; yeşil	www.wago.com/793-504/000-023
	Ürün no.: 793-505 WMB marking card; as card; MARKED; 31 ... 40 (10x); not stretchable; Horizontal marking; snap-on type; white	www.wago.com/793-505
	Ürün no.: 793-505/000-005 WMB etiket kartı; kart şeklinde; ETİKETLİ; 31 ... 40 (10x); not stretchable; Yatay etiketleme; takma tipi; kırmızı	www.wago.com/793-505/000-005
	Ürün no.: 793-505/000-006 WMB etiket kartı; kart şeklinde; ETİKETLİ; 31 ... 40 (10x); not stretchable; Yatay etiketleme; takma tipi; mavi	www.wago.com/793-505/000-006
	Ürün no.: 793-505/000-007 WMB etiket kartı; kart şeklinde; ETİKETLİ; 31 ... 40 (10x); not stretchable; Yatay etiketleme; takma tipi; gri	www.wago.com/793-505/000-007
	Ürün no.: 793-505/000-012 WMB etiket kartı; kart şeklinde; ETİKETLİ; 31 ... 40 (10x); not stretchable; Yatay etiketleme; takma tipi; turuncu	www.wago.com/793-505/000-012
	Ürün no.: 793-506 WMB etiket kartı; kart şeklinde; ETİKETLİ; 41 ... 50 (10x); not stretchable; Yatay etiketleme; takma tipi; beyaz	www.wago.com/793-506
	Ürün no.: 793-506/000-005 WMB etiket kartı; kart şeklinde; ETİKETLİ; 41 ... 50 (10x); not stretchable; Yatay etiketleme; takma tipi; kırmızı	www.wago.com/793-506/000-005
	Ürün no.: 793-506/000-006 WMB etiket kartı; kart şeklinde; ETİKETLİ; 41 ... 50 (10x); not stretchable; Yatay etiketleme; takma tipi; mavi	www.wago.com/793-506/000-006
	Ürün no.: 793-506/000-012 WMB etiket kartı; kart şeklinde; ETİKETLİ; 41 ... 50 (10x); not stretchable; Yatay etiketleme; takma tipi; turuncu	www.wago.com/793-506/000-012
	Ürün no.: 793-506/000-017 WMB etiket kartı; kart şeklinde; ETİKETLİ; 41 ... 50 (10x); not stretchable; Yatay etiketleme; takma tipi; açık yeşil	www.wago.com/793-506/000-017
	Ürün no.: 793-5501 WMB etiket kartı; kart şeklinde; 5 - 17,5 mm klemens genişliği için; uzatılabilir 5 - 5,2 mm; düz; takma tipi; beyaz	www.wago.com/793-5501

Değişikliklere tabidir.

	Ürün no.: 793-5501/000-002 WMB marking card; as card; for terminal block width 5 - 17.5 mm; stretchable 5 - 5.2 mm; plain; snap-on type; yellow	www.wago.com/793-5501/000-002
	Ürün no.: 793-5501/000-005 WMB marking card; as card; for terminal block width 5 - 17.5 mm; stretchable 5 - 5.2 mm; plain; snap-on type; red	www.wago.com/793-5501/000-005
	Ürün no.: 793-5501/000-006 WMB marking card; as card; for terminal block width 5 - 17.5 mm; stretchable 5 - 5.2 mm; plain; snap-on type; blue	www.wago.com/793-5501/000-006
	Ürün no.: 793-5501/000-007 WMB marking card; as card; for terminal block width 5 - 17.5 mm; stretchable 5 - 5.2 mm; plain; snap-on type; gray	www.wago.com/793-5501/000-007
	Ürün no.: 793-5501/000-012 WMB marking card; as card; for terminal block width 5 - 17.5 mm; stretchable 5 - 5.2 mm; plain; snap-on type; orange	www.wago.com/793-5501/000-012
	Ürün no.: 793-5501/000-014 WMB marking card; as card; for terminal block width 5 - 17.5 mm; stretchable 5 - 5.2 mm; plain; snap-on type; brown	www.wago.com/793-5501/000-014
	Ürün no.: 793-5501/000-017 WMB marking card; as card; for terminal block width 5 - 17.5 mm; stretchable 5 - 5.2 mm; plain; snap-on type; green	www.wago.com/793-5501/000-017
	Ürün no.: 793-5501/000-023 WMB marking card; as card; for terminal block width 5 - 17.5 mm; stretchable 5 - 5.2 mm; plain; snap-on type; light green	www.wago.com/793-5501/000-023
	Ürün no.: 793-5501/000-024 WMB marking card; as card; for terminal block width 5 - 17.5 mm; stretchable 5 - 5.2 mm; plain; snap-on type; violet	www.wago.com/793-5501/000-024
	Ürün no.: 793-566 WMB etiket kartı; kart şeklinde; ETİKETLİ; 1 ... 50 (2x); not stretchable; Yatay etiketleme; takma tipi; beyaz	www.wago.com/793-566
	Ürün no.: 793-566/000-002 WMB etiket kartı; kart şeklinde; ETİKETLİ; 1 ... 50 (2x); not stretchable; Yatay etiketleme; takma tipi; sarı	www.wago.com/793-566/000-002
	Ürün no.: 793-566/000-005 WMB etiket kartı; kart şeklinde; ETİKETLİ; 1 ... 50 (2x); not stretchable; Yatay etiketleme; takma tipi; kırmızı	www.wago.com/793-566/000-005
	Ürün no.: 793-566/000-006 WMB etiket kartı; kart şeklinde; ETİKETLİ; 1 ... 50 (2x); not stretchable; Yatay etiketleme; takma tipi; mavi	www.wago.com/793-566/000-006
	Ürün no.: 793-566/000-007 WMB etiket kartı; kart şeklinde; ETİKETLİ; 1 ... 50 (2x); not stretchable; Yatay etiketleme; takma tipi; gri	www.wago.com/793-566/000-007

Değişikliklere tabidir.

	Ürün no.: 793-566/000-012 WMB etiket kartı; kart şeklinde; ETİKETLİ; 1 ... 50 (2x); not stretchable; Yatay etiketleme; takma tipi; turuncu	www.wago.com/793-566/000-012
	Ürün no.: 793-566/000-017 WMB etiket kartı; kart şeklinde; ETİKETLİ; 1 ... 50 (2x); not stretchable; Yatay etiketleme; takma tipi; açık yeşil	www.wago.com/793-566/000-017
	Ürün no.: 793-566/000-023 WMB etiket kartı; kart şeklinde; ETİKETLİ; 1 ... 50 (2x); not stretchable; Yatay etiketleme; takma tipi; yeşil	www.wago.com/793-566/000-023
	Ürün no.: 793-566/000-024 WMB etiket kartı; kart şeklinde; ETİKETLİ; 1 ... 50 (2x); not stretchable; Yatay etiketleme; takma tipi; menekşe	www.wago.com/793-566/000-024
check		
	Ürün no.: 735-500 Test pini; 1 mm Ø; test kablosu için lehim bağlantılı	www.wago.com/735-500
tools		
	Ürün no.: 210-720 El aleti; Uç: 3,5 x 0,5 mm; kısmen yalıtılmış saplı	www.wago.com/210-720
Jumper		
	Ürün no.: 281-482 Comb-style jumper bar; insulated; 2-way; IN = IN terminal block; gray	www.wago.com/281-482
	Ürün no.: 859-402 Push-in type jumper bar; 2-way; Nominal current 18 A; insulated; light gray	www.wago.com/859-402
	Ürün no.: 859-402/000-005 Push-in type jumper bar; 2-way; Nominal current 18 A; insulated; red	www.wago.com/859-402/000-005
	Ürün no.: 859-402/000-006 Basma/itme tipi köprü çubuğu; 2 yollu; Nominal akım 18 A; yalıtımlı; mavi	www.wago.com/859-402/000-006
	Ürün no.: 859-402/000-029 Push-in type jumper bar; 2-way; Nominal current 18 A; insulated; yellow	www.wago.com/859-402/000-029
assembling		
	Ürün no.: 249-116 Screwless end stop; 6 mm wide; for DIN-rail 35 x 15 and 35 x 7.5; gray	www.wago.com/249-116
	Ürün no.: 249-117 Vidasız durdurucu; 10 mm genişlik; DIN-ray 35 x 15 ve 35 x 7,5 için; gri	www.wago.com/249-117
	Ürün no.: 249-197 Vidasız durdurucu; 14 mm genişlik; DIN-ray 35 x 15 ve 35 x 7,5 için; gri	www.wago.com/249-197

Değişikliklere tabidir.

WAGO Elektronik Sanayi ve Ticaret Ltd. Şti.
Yukarı Dudullu Mahallesi Bayraktar Bulvarı
Cad. Hattat Sok. No. 10 | 34775 Ümraniye - İstanbul
Tel.: +90 216 472 1133 111 | Fax: +90 216 472 9910
Email: info.tr@wago.com

Ürünlerimizle ilgili sorularınız mı var?
+90 216 472 1133 numaralı telefondan sizinle konuşmaktan mutluluk duyarız.

General accessories

Ürün no.: 2857-900 Konfigürasyon ekranı	www.wago.com/2857-900
Ürün no.: 750-921 Bluetooth® Adaptörü; açık gri	www.wago.com/750-921
Ürün no.: 750-923 Configuration cable; USB connector; Length: 2.5 m; black	www.wago.com/750-923
Ürün no.: 750-923/000-001 Konfigürasyon kablosu; USB konnektörü; Uzunluk: 5 m	www.wago.com/750-923/000-001
Ürün no.: 857-304 Relay module; Nominal input voltage: 24 VDC; 1 changeover contact; Limiting continuous current: 6 A; Yellow status indicator; Module width: 6 mm; 2,50 mm ² ; gray	www.wago.com/857-304
Ürün no.: 857-979 Besleme ve geçiş modülü; 2,50 mm ²	www.wago.com/857-979

power supply

 Ürün no.: 787-2852 Anahtarlama mod güç kaynağı; JUMPFLEX® Sinyal Çeviriciler için; 1 fazlı; 24 VDC çıkış gerilimi; 1 A çıkış akımı; -	www.wago.com/787-2852
---	--

**Dosya İndirme
Documentation****Instruction Leaflet**

JUMPFLEX®-Messumformer, TC-Grenzwertschalter	pdf 2,5 MB	İndir
--	---------------	-------

Additional Information

Disposal; Electrical and electronic equipment, Packaging	V 1.0.0	pdf 265,8 kB	İndir
--	---------	-----------------	-------

Engineering-Software**Software for Interface-Products**

WAGO Interface Configuration Software FULL The full setup, in addition to the WAGO Interface Configuration Software, includes the installation for the Microsoft .NET Framework.	1.6.3.7 17.Eyl.2019	exe 98,5 MB	İndir
WAGO Interface Configuration Software SMALL	1.6.3.7 17.Eyl.2019	exe 48,0 MB	İndir

Değişikliklere tabidir.

WAGO Elektronik Sanayi ve Ticaret Ltd. Şti.
Yukarı Dudullu Mahallesi Bayraktar Bulvarı
Cad. Hattat Sok. No. 10 | 34775 Ümraniye - İstanbul
Tel.: +90 216 472 1133 111 | Fax: +90 216 472 9910
Email: info.tr@wago.com

Ürünlerimizle ilgili sorularınız mı var?
+90 216 472 1133 numaralı telefondan sizinle konuşmaktan mutluluk duyuyoruz.

The full setup only includes the WAGO Interface Configuration Software.

CAD/CAE-Data

CAD data

2D/3D Models 2857-534

[URL](#)

[İndir](#)

CAE data

EPLAN Data Portal 2857-534

[URL](#)

[İndir](#)

WSCAD Universe 2857-534

[URL](#)

[İndir](#)

Installation Notes

Configuring

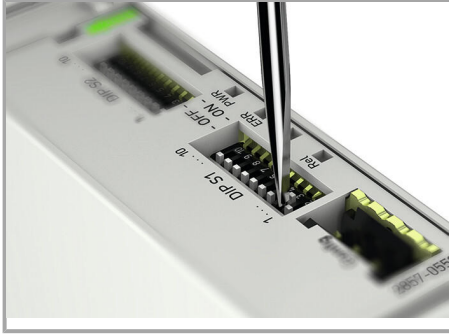

Configuration via DIP switches

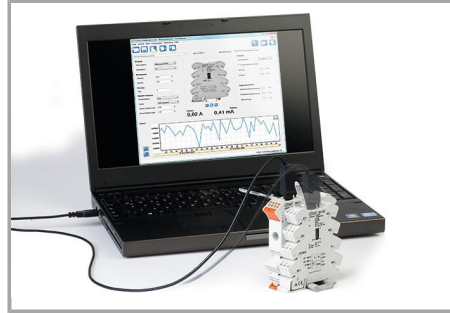

Configuration via WAGO interface configuration software

Değişikliklere tabidir.



Configuration via WAGO interface configuration app



Configuration via WAGO configuration display

Conductor termination

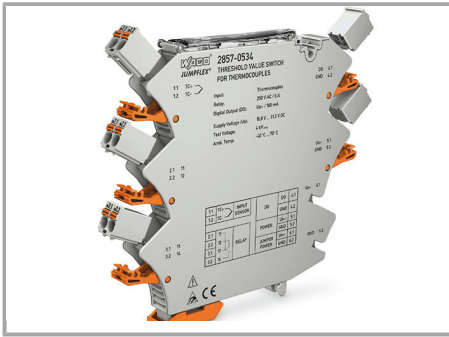

Pluggable connection technology

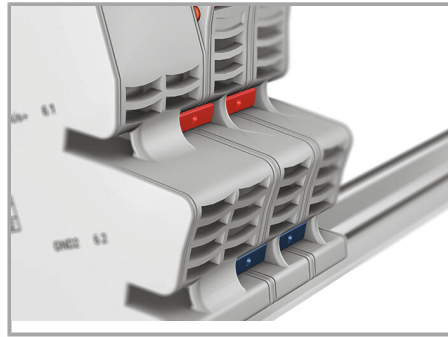

Commoning, not discrete wiring – same outline allows the use of a single in-line, push-in jumper

Değişikliklere tabidir.

WAGO Elektronik Sanayi ve Ticaret Ltd. Şti.
Yukarı Dudullu Mahallesi Bayraktar Bulvarı
Cad. Hattat Sok. No. 10 | 34775 Ümraniye - İstanbul
Tel.: +90 216 472 1133 111 | Fax: +90 216 472 9910
Email: info.tr@wago.com

Ürünlerimizle ilgili sorularınız mı var?
+90 216 472 1133 numaralı telefondan sizinle konuşmaktan mutluluk duyarız.

Safety

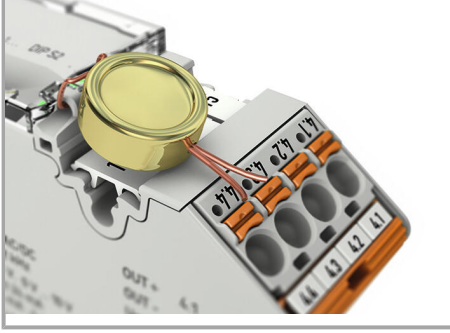

Lock-out seal option

Değişikliklere tabidir.

WAGO Elektronik Sanayi ve Ticaret Ltd. Şti.
Yukarı Dudullu Mahallesi Bayraktar Bulvarı
Cad. Hattat Sok. No. 10 | 34775 Ümraniye - İstanbul
Tel.: +90 216 472 1133 111 | Fax: +90 216 472 9910
Email: info.tr@wago.com

Ürünlerimizle ilgili sorularınız mı var?
+90 216 472 1133 numaralı telefondan sizinle konuşmaktan mutluluk
duyarız.