

Veri sayfası | Ürün numarası: 750-492

2-channel analog input; 4 ... 20 mA; Differential input; light gray

www.wago.com/750-492

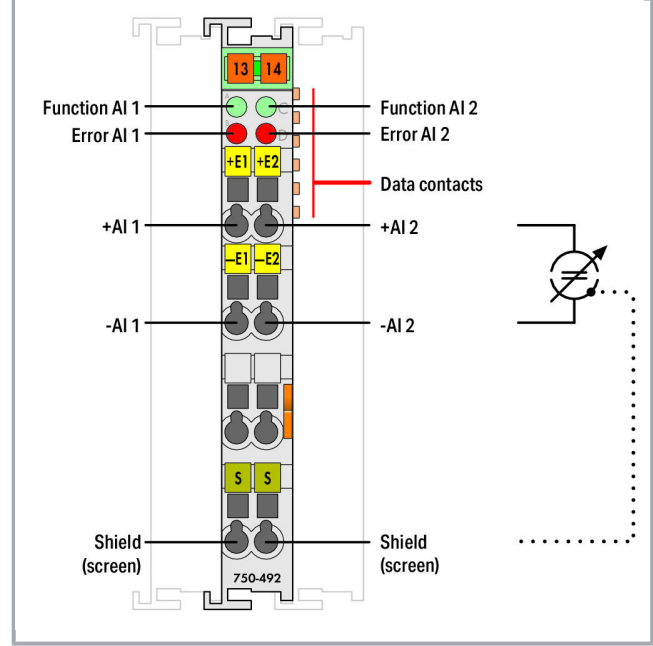

RoHS Compliant

BOMcheck.net

Renk: ■

Değişikliklere tabidir.

WAGO Elektronik Sanayi ve Ticaret Ltd. Şti.
Yukarı Dudullu Mahallesi Bayraktar Bulvarı
Cad. Hattat Sok. No. 10 | 34775 Ümraniye - İstanbul
Tel.: +90 216 472 1133 111 | Fax: +90 216 472 9910
Email: info.tr@wago.com

Ürünlerimizle ilgili sorularınız mı var?
+90 216 472 1133 numaralı telefondan sizinle konuşmaktan mutluluk duyarız.

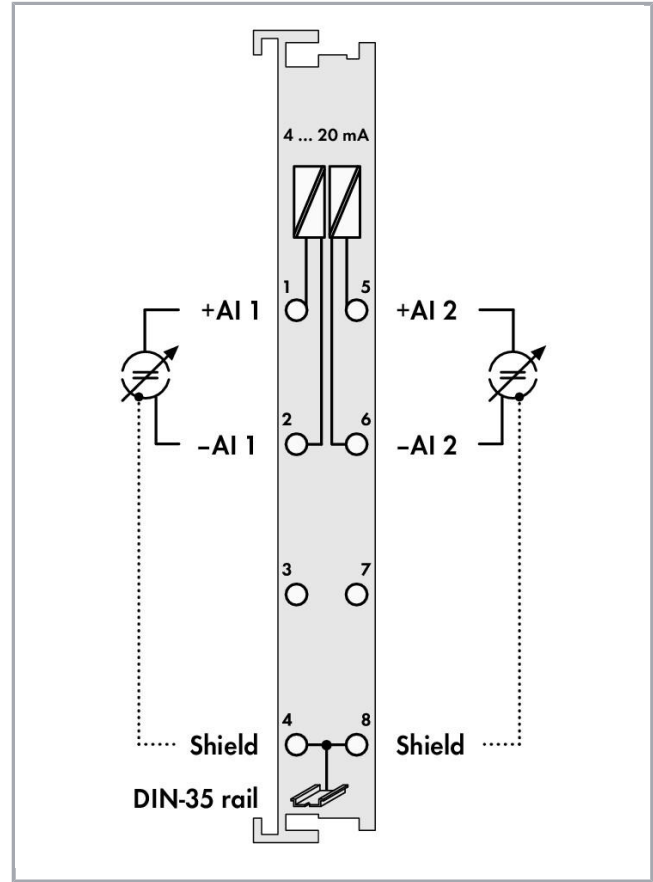
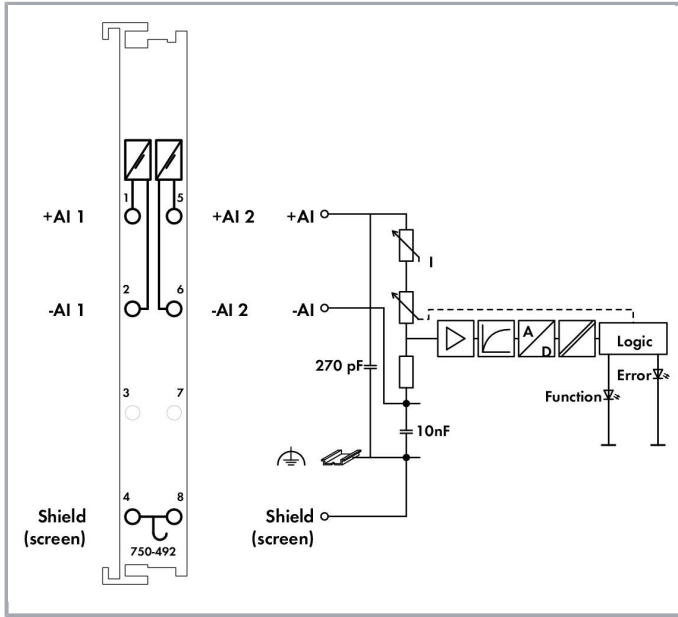

Ürün tanımı

2 kanallı analog giriş modülü 4-20 mA genlikte diferansiyel sinyalleri işler.

Her kanalın giriş sinyali elektriksel olarak yalıtılmış olup 13 bit çözünürlükte iletilir.

Modül, dahili sistem beslemesi tarafından beslenir.

Blendaj (ekran) doğrudan DIN raya bağlanır.

- Ölçülen değer alımı: zaman senkronizasyonlu (her iki giriş)
- Ölçüm aralığı aralık dışı: durum byte'i ve LED
- Dönüştürme yöntemi: SAR (Ardışık Yaklaşık Yazmacı)
- Çalışma modu: sürekli örnekleme (önayar)
- Koruma: doğrusal olmayan sınırlama

Değişikliklere tabidir.

WAGO Elektronik Sanayi ve Ticaret Ltd. Şti.
Yukarı Dudullu Mahallesi Bayraktar Bulvarı
Cad. Hattat Sok. No. 10 | 34775 Ümraniye - İstanbul
Tel.: +90 216 472 1133 111 | Fax: +90 216 472 9910
Email: info.tr@wago.com

Ürünlerimizle ilgili sorularınız mı var?

+90 216 472 1133 numaralı telefondan sizinle konuşmaktan mutluluk duyarız.



Veri

Technical Data

Number of analog inputs	2
Total number of channels (module)	2
Sinyal tipi	Current
Type of signal current	DC 4 ... 20 mA
Sensor connection	2 x (2-conductor)
Giriş filtresi	alçak geçiren birinci order, $f_G = 5$ kHz
Signal characteristic	Differential
Çözünürlük [bit]	13 Bit
Çalışma modu	Tetiklemeli (Önayar)
Input resistance max.	270 Ω
Bit genişliği	2 x 16 bit veri 2 x 8 bit kontrol/durum (isteğe bağlı)
Koruma	Non-linear limiting
Müsade edilen sürekli aşırı yük	30 V
Kanallar arası karışma zayıflaması	80 dB
Eksik kodsuz monotonluk	evet
Messfehler, Bezugstemperatur	25 °C
Messfehler, Abweichung max. vom Messbereichsendwert	0,05 %
Tüm sıcaklık aralığında hata	≤ 0.4 %
Temperaturfehler max. vom Messbereichsendwert	0,01 %/K
Örnekleme süresi	5 μ s
Örnekleme gecikmesi (kanal/kanal)	1 μ s
Örnekleme gecikmesi (modül)	1 ms
Tekrarlamanın örnekleme süresi	1 ms
Ölçüm aralığı aralık dışı	Status byte and LED
Ölçülen değer alımı	Time synchronous within the module
LSB (en önemsiz bit) değeri	2,4 μ A
Dönüştürme yöntemi	SAR (Successive Approximation Register)
System supply voltage	DC 5 V; via data contacts
Current consumption, system supply (5 V)	80 mA
izolasyon	500 V system/field or channel/channel

Bağlantı verisi

Connection technology: In-/Outputs

8 x CAGE CLAMP®

Değişikliklere tabidir.

WAGO Elektronik Sanayi ve Ticaret Ltd. Şti.
Yukarı Dudullu Mahallesi Bayraktar Bulvarı
Cad. Hattat Sok. No. 10 | 34775 Ümraniye - İstanbul
Tel.: +90 216 472 1133 111 | Fax: +90 216 472 9910
Email: info.tr@wago.com

Ürünlerimizle ilgili sorularınız mı var?
+90 216 472 1133 numaralı telefondan sizinle konuşmaktan mutluluk
duyarız.



Connection type (1)	Inputs/Outputs
Tek damarlı boylar	0,08 ... 2,5 mm ² / 28 ... 14 AWG
İnce bükümlü kablolar	0,08 ... 2,5 mm ² / 28 ... 14 AWG
Sıyırma uzunluğu	8 ... 9 mm / 0.31 ... 0.35 inch

Geometrical Data

Width	12 mm / 0.472 inch
Height	69,8 mm / 2.748 inch
DIN rayın üst kenarından yükseklik	62,6 mm / 2.465 inch
Depth	100 mm / 3.937 inch

Mekanik Veri

Montaj tipi	DIN 35 ray
-------------	------------

Material Data

Renk	açık gri
Gövde malzemesi	Polycarbonate, polyamide 6.6
Yangın yükü	0,943 MJ
Ağırlık	51 g
Uygunluk işareti	CE

Environmental Requirements

Surrounding air (operating) temperature	0 ... 55 °C
Surrounding air (storage) temperature	-40 ... 85 °C
Koruma sınıfı	IP20
Kirlilik derecesi (5)	2 per IEC 61131-2
Çalışma yüksekliği	0 ... 2000 m
Montaj pozisyonu	horizontal (standing/lying) or vertical
Nisbi nem (yoğuşmasız)	95 %
Titreşime dayanıklı	acc. to IEC 60068-2-6
Darbe direnci	15g per IEC 60068-2-27
EMC immunity to interference	acc. to EN 61000-6-2
EMU: 1 - enterferans emisyonu	acc. to EN 61000-6-4
Kirletici maddelere maruziyet	Per IEC 60068-2-42 and IEC 60068-2-43
Permissible H ₂ S contaminant concentration at a relative humidity 75 %	10 ppm

Değişikliklere tabidir.

WAGO Elektronik Sanayi ve Ticaret Ltd. Şti.
Yukarı Dudullu Mahallesi Bayraktar Bulvarı
Cad. Hattat Sok. No. 10 | 34775 Ümraniye - İstanbul
Tel.: +90 216 472 1133 111 | Fax: +90 216 472 9910
Email: info.tr@wago.com

Ürünlerimizle ilgili sorularınız mı var?
+90 216 472 1133 numaralı telefondan sizinle konuşmaktan mutluluk
duyarız.



Permissible SO₂ contaminant concentration at a relative humidity 75 25 ppm
%

Ticari Veri

Product Group	15 (Remote I/O)
SAP'den ambalaj tipi	BOX
Country of origin	DE
GTIN	4045454470296
Customs Tariff No.	85389099990

Onaylar / Belgeler

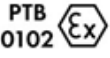
Ex Onayları

Logo	Onay	İlave Onay Metni	Belge adı
	ATEX TUEV Nord Cert GmbH	EN 60079-0	TÜV 07 ATEX 554086 X en.
	TUEV Nord TUEV Nord Cert GmbH	IEC 60079-0	IECEX TUN 09.0001 X
	UL Underwriters Laboratories Inc. (HAZARDOUS LOCATIONS)	UL 121201	E198726 Sec.1

Denizcilik Onayları

Logo	Onay	İlave Onay Metni	Belge adı
	KC National Radio Research Agency	Article 58-2, Clause 3	MSIP- REM- W43- AIM750

UL-Approvals

Logo	Onay	İlave Onay Metni	Belge adı
	UL UL International Netherlands B.V. (ORDINARY LOCATIONS)	UL 508	E175199 Sec.1

Değişikliklere tabidir.



Counterpart

Uyumlu ürünler

Carrier rail













	Ürün no.: 210-112 Steel carrier rail; 35 x 7.5 mm; 1 mm thick; 2 m long; slotted; according to EN 60715; "Hole width 25 mm	www.wago.com/210-112
	Ürün no.: 210-113 Çelik taşıyıcı ray; 35 x 7,5 mm; 1 mm kalınlık; 2 m uzunluk; yuvasız; EN 60715'e göre	www.wago.com/210-113
	Ürün no.: 210-114 Steel carrier rail; 35 x 15 mm; 1.5 mm thick; 2 m long; unslotted; similar to EN 60715	www.wago.com/210-114
	Ürün no.: 210-115 Çelik taşıyıcı ray; 35 x 7,5 mm; 1 mm kalınlık; 2 m uzunluk; yuvalı; EN 60715'e göre; "Delik genişliği 18 mm	www.wago.com/210-115
	Ürün no.: 210-118 Çelik taşıyıcı ray; 35 x 15 mm; 2,3 mm kalınlık; 2 m uzunluk; yuvasız; EN 60715'e göre	www.wago.com/210-118
	Ürün no.: 210-196 Alüminyum taşıyıcı ray; 35 x 8,2 mm; 1,6 mm kalınlık; 2 m uzunluk; yuvasız; EN 60715'e benzer; gümüş-renkli	www.wago.com/210-196
	Ürün no.: 210-197 Çelik taşıyıcı ray; 35 x 15 mm; 1,5 mm kalınlık; 2 m uzunluk; yuvalı; EN 60715'e benzer	www.wago.com/210-197
	Ürün no.: 210-198 Copper carrier rail; 35 x 15 mm; 2,3 mm thick; 2 m long; unslotted; according to EN 60715; copper-colored	www.wago.com/210-198
	Ürün no.: 210-504 Çelik taşıyıcı ray; 35 x 7,5 mm; 1 mm kalınlık; 2 m uzunluk; yuvalı; galvanize; EN 60715'e göre	www.wago.com/210-504
	Ürün no.: 210-505 Steel carrier rail; 35 x 7.5 mm; 1 mm thick; 2 m long; unslotted; galvanized; according to EN 60715	www.wago.com/210-505
	Ürün no.: 210-506 Steel carrier rail; 35 x 15 mm; 1.5 mm thick; 2 m long; unslotted; galvanized; similar to EN 60715	www.wago.com/210-506
	Ürün no.: 210-508 Steel carrier rail; 35 x 15 mm; 1.5 mm thick; 2 m long; slotted; galvanized; similar to EN 60715	www.wago.com/210-508

Değişikliklere tabidir.

WAGO Elektronik Sanayi ve Ticaret Ltd. Şti.
Yukarı Dudullu Mahallesi Bayraktar Bulvarı
Cad. Hattat Sok. No. 10 | 34775 Ümraniye - İstanbul
Tel.: +90 216 472 1133 111 | Fax: +90 216 472 9910
Email: info.tr@wago.com

Ürünlerimizle ilgili sorularınız mı var?
+90 216 472 1133 numaralı telefondan sizinle konuşmaktan mutluluk
duyarız.

Marking accessories

	Ürün no.: 2009-145 Mini-WSB Inline; for Smart Printer; 1700 pieces on roll; stretchable 5 - 5.2 mm; plain; snap-on type; white	www.wago.com/2009-145
	Ürün no.: 2009-145/000-002 Mini-WSB Inline; for Smart Printer; 1700 pieces on roll; stretchable 5 - 5.2 mm; plain; snap-on type; white /000-002	www.wago.com/2009-145
	Ürün no.: 2009-145/000-005 Mini-WSB Inline; for Smart Printer; 1700 pieces on roll; stretchable 5 - 5.2 mm; plain; snap-on type; red /000-005	www.wago.com/2009-145
	Ürün no.: 2009-145/000-006 Mini-WSB Inline; for Smart Printer; 1700 pieces on roll; stretchable 5 - 5.2 mm; plain; snap-on type; blue /000-006	www.wago.com/2009-145
	Ürün no.: 2009-145/000-007 Mini-WSB Inline; for Smart Printer; 1700 pieces on roll; stretchable 5 - 5.2 mm; plain; snap-on type; white /000-007	www.wago.com/2009-145
	Ürün no.: 2009-145/000-012 Mini-WSB Inline; for Smart Printer; 1700 pieces on roll; stretchable 5 - 5.2 mm; plain; snap-on type; orange	www.wago.com/2009-145
	Ürün no.: 2009-145/000-023 Mini-WSB Inline; for Smart Printer; 1700 pieces on roll; stretchable 5 - 5.2 mm; plain; snap-on type; green	www.wago.com/2009-145
	Ürün no.: 2009-145/000-024 Mini-WSB Inline; for Smart Printer; 1700 pieces on roll; stretchable 5 - 5.2 mm; plain; snap-on type; violet	www.wago.com/2009-145
	Ürün no.: 248-501 Minyatür WSB Hızlı etiketleme sistemi; düz; Etiket genişliği 5 mm; her kartta 10 etiketli 10 şerit	www.wago.com/248-501
	Ürün no.: 248-501/000-002 Mini-WSB etiket kartı; kart şeklinde; not stretchable; düz; takma tipi; sarı	www.wago.com/248-501
	Ürün no.: 248-501/000-005 Mini-WSB etiket kartı; kart şeklinde; not stretchable; düz; takma tipi; kırmızı	www.wago.com/248-501
	Ürün no.: 248-501/000-006 Mini-WSB etiket kartı; kart şeklinde; not stretchable; düz; takma tipi; mavi	www.wago.com/248-501
	Ürün no.: 248-501/000-007 Mini-WSB etiket kartı; kart şeklinde; not stretchable; düz; takma tipi; gri	www.wago.com/248-501

Değişikliklere tabidir.

**Ürün no.:** 248-501/000-012

Mini-WSB marking card; as card; not stretchable; plain; snap-on type; orange

www.wago.com/248-501/000-012**Ürün no.:** 248-501/000-017

Mini-WSB etiket kartı; kart şeklinde; not stretchable; düz; takma tipi; açık yeşil

www.wago.com/248-501/000-017**Ürün no.:** 248-501/000-023

Mini-WSB etiket kartı; kart şeklinde; not stretchable; düz; takma tipi; yeşil

www.wago.com/248-501/000-023**Ürün no.:** 248-501/000-024

Mini-WSB etiket kartı; kart şeklinde; not stretchable; düz; takma tipi; menekşe

www.wago.com/248-501/000-024**Ürün no.:** 750-100

Marker card; as a DIN A4 sheet; plain; white

www.wago.com/750-100**Ürün no.:** 750-103

Group marker carrier; transparent

www.wago.com/750-103**Ürün no.:** 750-106

Group marker carrier; transparent

www.wago.com/750-106**shield connection****Ürün no.:** 790-108

Blendaj sıkıştırma yuvası; 11 mm genişlik; uyumlu iletken çapı; 3 ... 8 mm

www.wago.com/790-108**Ürün no.:** 790-116

Shield clamping saddle; 19 mm wide; diameter of compatible conductor; 7 ... 16 mm

www.wago.com/790-116**Ürün no.:** 790-124

Blendaj sıkıştırma yuvası; 27 mm genişlik; uyumlu iletken çapı; 6 ... 24 mm

www.wago.com/790-124**Ürün no.:** 790-140

Shield clamping saddle; diameter of compatible conductor

www.wago.com/790-140**Ürün no.:** 790-208

Shield clamping saddle; 12.4 mm wide; 3 ... 8 mm

www.wago.com/790-208**Ürün no.:** 790-216

Blendaj sıkıştırma yuvası; 21,8 mm genişlik; 6 ... 16 mm

www.wago.com/790-216**Ürün no.:** 790-220

Shield clamping saddle; 30 mm wide; 6 ... 20 mm

www.wago.com/790-220**system box****Ürün no.:** 850-804

IP65 gövde; Paslanmaz çelik; G x Y x D (400 x 123 x 200 mm); 4 x M20, 16 x M16, 28 x M12 kablo çorabı

www.wago.com/850-804**Ürün no.:** 850-804/000-001

IP65 gövde; Paslanmaz çelik; G x Y x D (400 x 123 x 200 mm); 2 x M20, 13 x M16, 32 x M12 kablo çorabı

www.wago.com/850-804/000-001

Değişikliklere tabidir.

**Ürün no.: 850-805**

IP65 gövde; Paslanmaz çelik; G x Y x D (600 x 123 x 200 mm); 4 x M20, 19 x M16, 67 x M12 kablo çorabı

www.wago.com/850-805**Ürün no.: 850-814/002-000**

IP65 gövde; Çelik sac (RAL 7035); G x Y x D (200 x 120 x 200 mm); flanş plakasız

www.wago.com/850-814/002-000**Ürün no.: 850-815/002-000**

IP65 gövde; Çelik sac (RAL 7035); G x Y x D (300 x 120 x 200 mm); flanş plakasız

www.wago.com/850-815/002-000**Ürün no.: 850-816/002-000**

IP65 enclosure; Sheet steel (RAL 7035); WxHxD (400x120x200 mm); without flange plate

www.wago.com/850-816/002-000**Ürün no.: 850-817/002-000**

IP65 enclosure; Sheet steel (RAL 7035); WxHxD (600x120x200 mm); without flange plate

www.wago.com/850-817/002-000**Ürün no.: 850-825**

IP65 gövde; Alüminyum (RAL 7032); G x Y x D (160 x 100 x 160 mm); 9 x M12, 4 x M20

www.wago.com/850-825**Ürün no.: 850-826**

IP65 gövde; Alüminyum (RAL 7032); G x Y x D (240 x 100 x 160 mm); 4 x M20, 4 x M16, 14 x M12 kablo çorabı

www.wago.com/850-826**Ürün no.: 850-826/002-000**

IP65 gövde; Alüminyum (RAL 7035); G x Y x D (240 x 100 x 160 mm); 4 x M20, 4 x M16, 14 x M12 kablo çorabı

www.wago.com/850-826/002-000**Ürün no.: 850-827**

IP65 enclosure; Aluminium (RAL 7032); WxHxD (320x100x160 mm); 4 x M20, 8 x M16, 17 x M12 cable grip

www.wago.com/850-827**Ürün no.: 850-827/002-000**

IP65 gövde; Alüminyum (RAL 7035); G x Y x D (320 x 100 x 160 mm); 4 x M20, 8 x M16, 17 x M12 kablo çorabı

www.wago.com/850-827/002-000**Ürün no.: 850-828**

IP65 gövde; Alüminyum (RAL 7032); G x Y x D (480 x 100 x 160 mm); 4 x M20, 10 x M16, 35 x M12 kablo çorabı

www.wago.com/850-828**Ürün no.: 850-828/002-000**

IP65 gövde; Alüminyum (RAL 7035); G x Y x D (480 x 100 x 160 mm); 4 x M20, 10 x M16, 35 x M12 kablo çorabı

www.wago.com/850-828/002-000**Ürün no.: 850-834**

IP65 gövde; Polyester (RAL 7032); G x Y x D (164 x 100 x 164 mm); 9 x M12, 4 x M20

www.wago.com/850-834**Ürün no.: 850-835**

IP65 enclosure; Polyester (RAL 7032); WxHxD (244x100x164 mm); 4 x M20, 4 x M16, 14 x M12 cable grip

www.wago.com/850-835

Değişikliklere tabidir.

WAGO Elektronik Sanayi ve Ticaret Ltd. Şti.
Yukarı Dudullu Mahallesi Bayraktar Bulvarı
Cad. Hattat Sok. No. 10 | 34775 Ümraniye - İstanbul
Tel.: +90 216 472 1133 111 | Fax: +90 216 472 9910
Email: info.tr@wago.com

Ürünlerimizle ilgili sorularınız mı var?
+90 216 472 1133 numaralı telefondan sizinle konuşmaktan mutluluk
duyarız.



Ürün no.: 850-836

IP65 gövde; Polyester (RAL 7032); G x Y x D (324 x 100 x 164 mm); 4 x M20, 8 x M16, 17 x M12 kablo çorabı

www.wago.com/850-836

Dosya İndirme Documentation

Manual

2-channel, 4-20mA Differential measuring input	V 1.1.0	pdf 2,0 MB	İndir
---	---------	---------------	-------

Additional Information

Disposal; Electrical and electronic equipment, Packaging	V 1.0.0	pdf 265,8 kB	İndir
--	---------	-----------------	-------

System Description

Overview on WAGO-I/O-SYSTEM 750 approvals		pdf 780,2 kB	İndir
---	--	-----------------	-------

Use in Hazardous Environments Term definition, marking and installation regulations	V 1.0.0	pdf 1,0 MB	İndir
--	---------	---------------	-------

750/753 Series I/O-System – General Product Information		pdf 1,7 MB	İndir
---	--	---------------	-------

Design Notes Basic conditions and recommendations for higher operational safety	V 2.0.0	pdf 1,5 MB	İndir
--	---------	---------------	-------

CAD/CAE-Data

CAD data

2D/3D Models 750-492		URL	İndir
----------------------	--	-----	-------

CAE data

EPLAN Data Portal 750-492		URL	İndir
---------------------------	--	-----	-------

WSCAD Universe 750-492		URL	İndir
------------------------	--	-----	-------

Değişikliklere tabidir.

WAGO Elektronik Sanayi ve Ticaret Ltd. Şti.
Yukarı Dudullu Mahallesi Bayraktar Bulvarı
Cad. Hattat Sok. No. 10 | 34775 Ümraniye - İstanbul
Tel.: +90 216 472 1133 111 | Fax: +90 216 472 9910
Email: info.tr@wago.com

Ürünlerimizle ilgili sorularınız mı var?
+90 216 472 1133 numaralı telefondan sizinle konuşmaktan mutluluk
duyarız.



Device Files

Device Driver

WAGO USB Service Kabel Treiber / Serie 750 und 857

6.5.3.0

10.Eyl.2014

zip

4,8 MB

İndir

Installation Notes

Ürün ailesi

[750/753 Series – I/O System](#)

[Show all products from the family](#)

Değişikliklere tabidir.

WAGO Elektronik Sanayi ve Ticaret Ltd. Şti.
Yukarı Dudullu Mahallesi Bayraktar Bulvarı
Cad. Hattat Sok. No. 10 | 34775 Ümraniye - İstanbul
Tel.: +90 216 472 1133 111 | Fax: +90 216 472 9910
Email: info.tr@wago.com

Ürünlerimizle ilgili sorularınız mı var?
+90 216 472 1133 numaralı telefondan sizinle konuşmaktan mutluluk
duyarız.