

Veri sayfası | Ürün numarası: 750-474

2 kanallı analog giriş; 4 ... 20 mA; Tek uçlu; 16 bit; açık gri

[www.wago.com/750-474](http://www.wago.com/750-474)

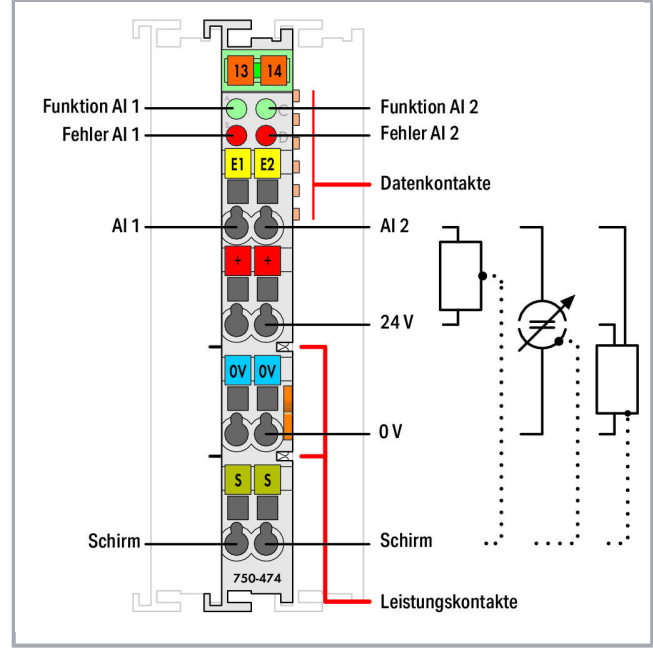
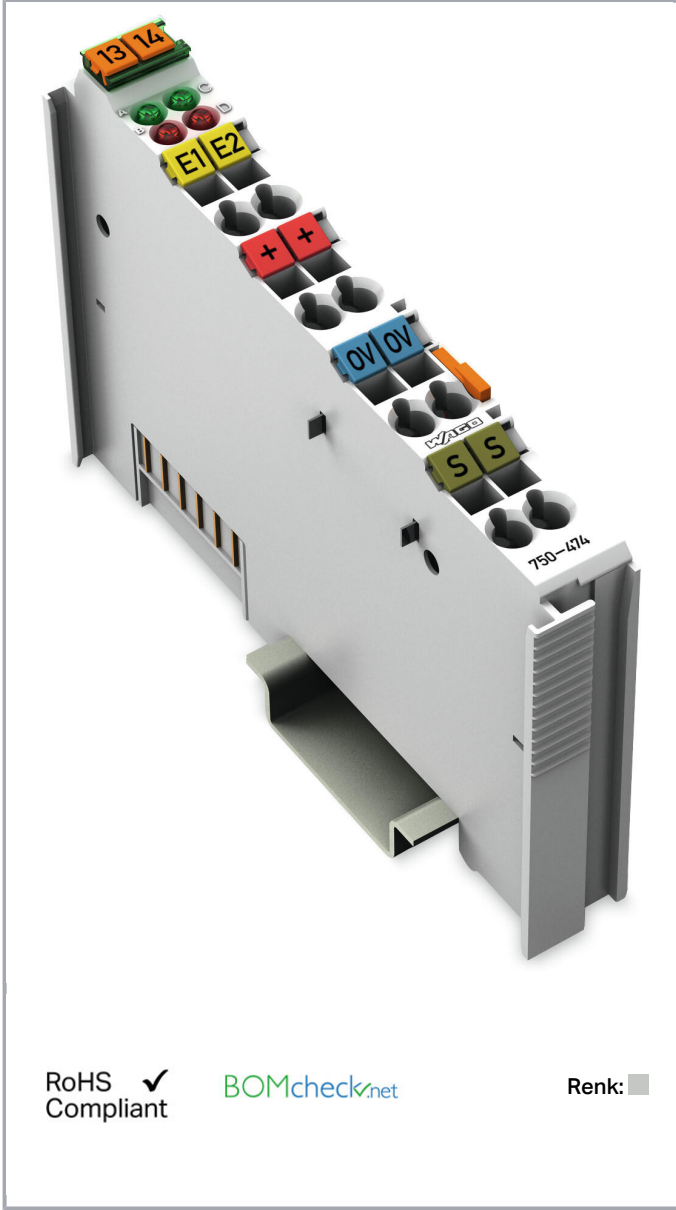

RoHS  Compliant

BOMcheck.net

Renk: ■

Değişikliklere tabidir.

WAGO Elektronik Sanayi ve Ticaret Ltd. Şti.  
Yukarı Dudullu Mahallesi Bayraktar Bulvarı  
Cad. Hattat Sok. No. 10 | 34775 Ümraniye - İstanbul  
Tel.: +90 216 472 1133 111 | Fax: +90 216 472 9910  
Email: [info.tr@wago.com](mailto:info.tr@wago.com)

Ürünlerimizle ilgili sorularınız mı var?  
+90 216 472 1133 numaralı telefondan sizinle konuşmaktan mutluluk duyarız.

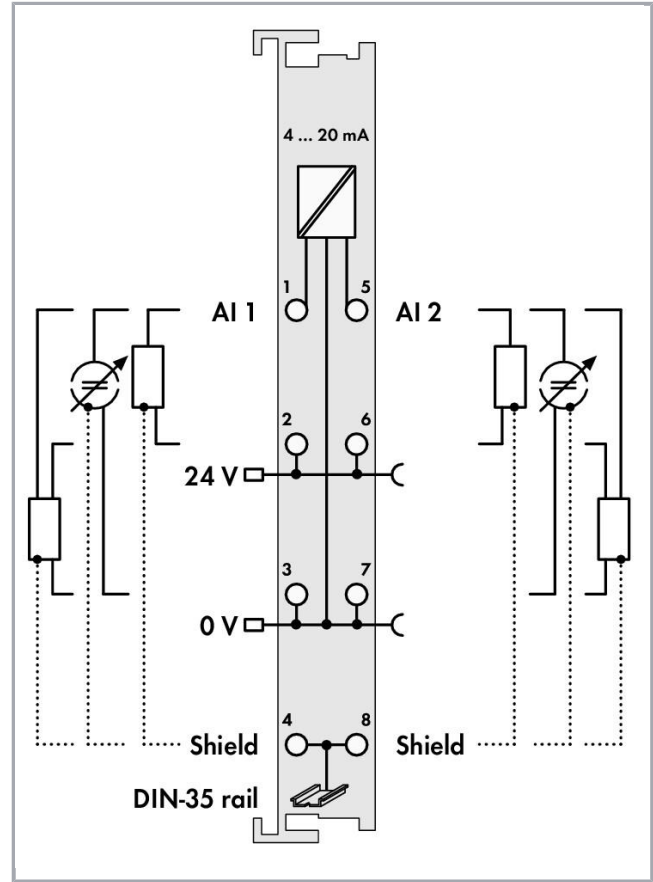
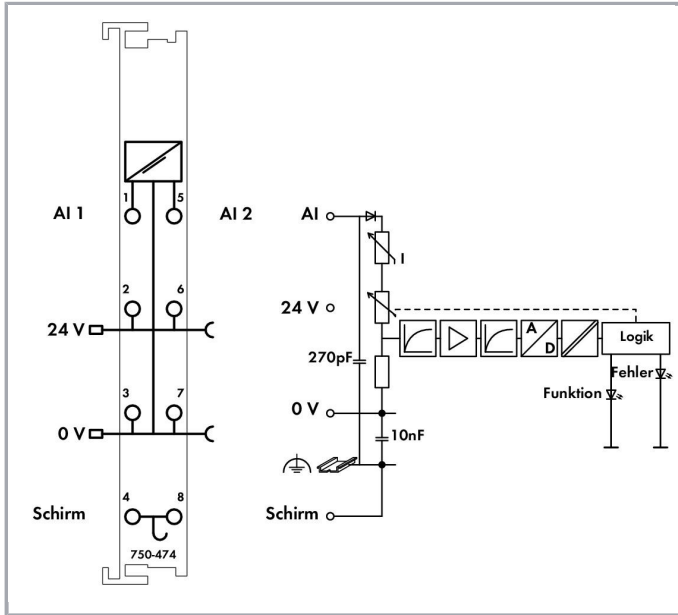

## Ürün tanımı

Analog giriş modülü transdüserleri besler, gönderilen analog sinyalleri alır ve elektriksel olarak yalıtılmış olarak sinyalleri fieldbus'a gönderir.

24V'luk saha gerilim beslemesi modülün güç köprü kontaktlarından alınır.

Blendaj (ekran) doğrudan DIN rayına bağlanır.

Yaklaşık 25 mA'de aşırı yük koruması ölçüm girişini yüksek direnç durumuna alır. Normal çalışma koşullarında otomatik olarak eski durumuna döner.

Bu giriş modülü 2 telli transdüserlere gerilim besleyebilir.

## Veri

### Technical Data

Number of analog inputs	2
Total number of channels (module)	2
Sinyal tipi	Current
Type of signal current	DC 4 ... 20 mA

Değişikliklere tabidir.

WAGO Elektronik Sanayi ve Ticaret Ltd. Şti.  
Yukarı Dudullu Mahallesi Bayraktar Bulvarı  
Cad. Hattat Sok. No. 10 | 34775 Ümraniye - İstanbul  
Tel.: +90 216 472 1133 111 | Fax: +90 216 472 9910  
Email: [info.tr@wago.com](mailto:info.tr@wago.com)

Ürünlerimizle ilgili sorularınız mı var?  
+90 216 472 1133 numaralı telefondan sizinle konuşmaktan mutluluk duyarız.



Sensor connection	2 x (2-conductor, 3-conductor)
Eingangsfiterfrequenz analog	50 Hz
Giriş gerilimi (maks.)	24 V
Giriş gerilimi	lineer değil, aşırı yük korumalı $V = 1,2V + 100 \Omega \times I$ ölç.
Signal characteristic	Single-ended
Çözünürlük [bit]	15 Bit
Input resistance max.	220 $\Omega$
Bit genişliği	2 x 16 bit veri 2 x 8 bit kontrol/durum (isteğe bağlı)
Aşırı gerilim koruması	30 V ters polarite koruması
Örnekleme frekansında gürültü bastırma	-100 dB
Örnekleme frekansı üzerinde gürültü bastırma	-40 dB
Çevirme süresi (tip.)	80 ms
Messfehler, Bezugstemperatur	25 °C
Messfehler, Abweichung max. vom Messbereichsendwert	0,1 %
Temperaturfehler max. vom Messbereichsendwert	0,01 %/K
System supply voltage	DC 5 V; via data contacts
Current consumption, system supply (5 V)	75 mA
Field supply voltage	DC 24 V (-25 ... +30 %); über Leistungskontakte (Einspeisung über Messerkontakt; Weiterleitung über Federkontakt)
İzolasyon	500 V sistem/besleme
Number of incoming power jumper contacts	2
Number of outgoing power jumper contacts	2

### Bağlantı verisi

Connection technology: In-/Outputs	8 x CAGE CLAMP®
Connection type (1)	Inputs/Outputs
Tek damarlı boylar	0,08 ... 2,5 mm <sup>2</sup> / 28 ... 14 AWG
İnce bükümlü kablolar	0,08 ... 2,5 mm <sup>2</sup> / 28 ... 14 AWG
Sıyırma uzunluğu	8 ... 9 mm / 0.31 ... 0.35 inch

### Geometrical Data

Width	12 mm / 0.472 inch
Height	69,8 mm / 2.748 inch
DIN rayın üst kenarından yükseklik	62,6 mm / 2.465 inch
Depth	100 mm / 3.937 inch

Değişikliklere tabidir.

WAGO Elektronik Sanayi ve Ticaret Ltd. Şti.  
Yukarı Dudullu Mahallesi Bayraktar Bulvarı  
Cad. Hattat Sok. No. 10 | 34775 Ümraniye - İstanbul  
Tel.: +90 216 472 1133 111 | Fax: +90 216 472 9910  
Email: [info.tr@wago.com](mailto:info.tr@wago.com)

Ürünlerimizle ilgili sorularınız mı var?  
+90 216 472 1133 numaralı telefondan sizinle konuşmaktan mutluluk  
duyarız.



## Mekanik Veri

Montaj tipi	DIN 35 ray
-------------	------------

## Material Data

Renk	açık gri
Gövde malzemesi	Polycarbonate, polyamide 6.6
Yangın yükü	1,311 MJ
Ağırlık	53,2 g
Uygunluk işareti	CE

## Environmental Requirements

Surrounding air (operating) temperature	0 ... 55 °C
Surrounding air (storage) temperature	-40 ... 85 °C
Koruma sınıfı	IP20
Kirlilik derecesi (5)	2 per IEC 61131-2
Çalışma yüksekliği	0 ... 2000 m
Montaj pozisyonu	horizontal (standing/lying) or vertical
Nisbi nem (yoğuşmasız)	95 %
Titreşime dayanıklı	4g per IEC 60068-2-6
Darbe direnci	15g per IEC 60068-2-27
EMC immunity to interference	acc. to EN 61000-6-2, marine applications
EMU: 1 - enterferans emisyonu	acc. to EN 61000-6-4, marine applications
Kirletici maddelere maruziyet	Per IEC 60068-2-42 and IEC 60068-2-43
Permissible H <sub>2</sub> S contaminant concentration at a relative humidity 75 %	10 ppm
Permissible SO <sub>2</sub> contaminant concentration at a relative humidity 75 %	25 ppm

## Ticari Veri

Product Group	15 (Remote I/O)
SAP'den ambalaj tipi	BOX
Country of origin	DE
GTIN	4045454393281
Customs Tariff No.	85389099990



Değişikliklere tabidir.

WAGO Elektronik Sanayi ve Ticaret Ltd. Şti.  
Yukarı Dudullu Mahallesi Bayraktar Bulvarı  
Cad. Hattat Sok. No. 10 | 34775 Ümraniye - İstanbul  
Tel.: +90 216 472 1133 111 | Fax: +90 216 472 9910  
Email: [info.tr@wago.com](mailto:info.tr@wago.com)

Ürünlerimizle ilgili sorularınız mı var?  
+90 216 472 1133 numaralı telefondan sizinle konuşmaktan mutluluk  
duyarız.

## Onaylar / Belgeler

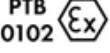
## Ex Onayları

Logo	Onay	İlave Onay Metni	Belge adı
	ATEX TUEV Nord Cert GmbH	EN 60079-0	TÜV 07 ATEX 554086 X en.
	TUEV Nord TUEV Nord Cert GmbH	IEC 60079-0	IECEX TUN 09.0001 X
	UL Underwriters Laboratories Inc. (HAZARDOUS LOCATIONS)	UL 121201	E198726 Sec.1

## Denizcilik Onayları

Logo	Onay	İlave Onay Metni	Belge adı
	KC National Radio Research Agency	Article 58-2, Clause 3	MSIP- REM- W43- AIM750





## Diğer Onaylar

Logo	Onay	İlave Onay Metni	Belge adı
	ABS American Bureau of Shipping	-	19- HG1821926
	BV Bureau Veritas S.A.	-	13453/DO BV
	DNV GL Det Norske Veritas, Germanischer Lloyd	-	TAA0000194
	KR Korean Register of Shipping	-	KR HMB05880- AC001

Değişikliklere tabidir.

WAGO Elektronik Sanayi ve Ticaret Ltd. Şti.  
Yukarı Dudullu Mahallesi Bayraktar Bulvarı  
Cad. Hattat Sok. No. 10 | 34775 Ümraniye - İstanbul  
Tel.: +90 216 472 1133 111 | Fax: +90 216 472 9910  
Email: info.tr@wago.com

Ürünlerimizle ilgili sorularınız mı var?  
+90 216 472 1133 numaralı telefondan sizinle konuşmaktan mutluluk  
duyarız.

	LR Lloyds Register	-	02/20026 (E6)
	NK Nippon Kaiji Kyokai	-	TA17255M
	PRS Polski Rejestr Statków	-	TE/2236 /880590/19
	RINA RINA Germany GmbH	-	ELE066419XG



## UL-Approvals

Logo	Onay	İlave Onay Metni	Belge adı
	UL UL International Netherlands B.V. (ORDINARY LOCATIONS)	UL 508	E175199 Sec.1

## Counterpart

## Uyumlu ürünler

## Supply module

	Ürün no.: 750-601 Güç Kaynağı; 24 VDC; sigorta yuvası; açık gri	<a href="http://www.wago.com/750-601">www.wago.com/750-601</a>
	Ürün no.: 750-602 Güç Kaynağı; 24 VDC; açık gri	<a href="http://www.wago.com/750-602">www.wago.com/750-602</a>
	Ürün no.: 750-610 Güç Kaynağı; 24 VDC; sigorta yuvası; Arıza teşhisi	<a href="http://www.wago.com/750-610">www.wago.com/750-610</a>

Değişikliklere tabidir.

WAGO Elektronik Sanayi ve Ticaret Ltd. Şti.  
Yukarı Dudullu Mahallesi Bayraktar Bulvarı  
Cad. Hattat Sok. No. 10 | 34775 Ümraniye - İstanbul  
Tel.: +90 216 472 1133 111 | Fax: +90 216 472 9910  
Email: [info.tr@wago.com](mailto:info.tr@wago.com)

Ürünlerimizle ilgili sorularınız mı var?  
+90 216 472 1133 numaralı telefondan sizinle konuşmaktan mutluluk  
duyarız.















Ürün no.: 750-612

Güç Kaynağı; 0 ... 230 V AC/DC; açık gri

[www.wago.com/750-612](http://www.wago.com/750-612)

## Marking accessories

	<b>Ürün no.: 2009-145</b> Mini-WSB Inline; for Smart Printer; 1700 pieces on roll; stretchable 5 - 5.2 mm; plain; snap-on type; white	<a href="http://www.wago.com/2009-145">www.wago.com/2009-145</a>
	<b>Ürün no.: 2009-145/000-002</b> Mini-WSB Inline; for Smart Printer; 1700 pieces on roll; stretchable 5 - 5.2 mm; plain; snap-on type; white /000-002	<a href="http://www.wago.com/2009-145">www.wago.com/2009-145</a>
	<b>Ürün no.: 2009-145/000-005</b> Mini-WSB Inline; for Smart Printer; 1700 pieces on roll; stretchable 5 - 5.2 mm; plain; snap-on type; red /000-005	<a href="http://www.wago.com/2009-145">www.wago.com/2009-145</a>
	<b>Ürün no.: 2009-145/000-006</b> Mini-WSB Inline; for Smart Printer; 1700 pieces on roll; stretchable 5 - 5.2 mm; plain; snap-on type; blue /000-006	<a href="http://www.wago.com/2009-145">www.wago.com/2009-145</a>
	<b>Ürün no.: 2009-145/000-007</b> Mini-WSB Inline; for Smart Printer; 1700 pieces on roll; stretchable 5 - 5.2 mm; plain; snap-on type; white /000-007	<a href="http://www.wago.com/2009-145">www.wago.com/2009-145</a>
	<b>Ürün no.: 2009-145/000-012</b> Mini-WSB Inline; for Smart Printer; 1700 pieces on roll; stretchable 5 - 5.2 mm; plain; snap-on type; orange	<a href="http://www.wago.com/2009-145">www.wago.com/2009-145</a>
	<b>Ürün no.: 2009-145/000-023</b> Mini-WSB Inline; for Smart Printer; 1700 pieces on roll; stretchable 5 - 5.2 mm; plain; snap-on type; green	<a href="http://www.wago.com/2009-145">www.wago.com/2009-145</a>
	<b>Ürün no.: 2009-145/000-024</b> Mini-WSB Inline; for Smart Printer; 1700 pieces on roll; stretchable 5 - 5.2 mm; plain; snap-on type; violet	<a href="http://www.wago.com/2009-145">www.wago.com/2009-145</a>
	<b>Ürün no.: 248-501</b> Minyatür WSB Hızlı etiketleme sistemi; düz; Etiket genişliği 5 mm; her kartta 10 etiketli 10 şerit	<a href="http://www.wago.com/248-501">www.wago.com/248-501</a>
	<b>Ürün no.: 248-501/000-002</b> Mini-WSB etiket kartı; kart şeklinde; not stretchable; düz; takma tipi; sarı	<a href="http://www.wago.com/248-501">www.wago.com/248-501</a>
	<b>Ürün no.: 248-501/000-005</b> Mini-WSB etiket kartı; kart şeklinde; not stretchable; düz; takma tipi; kırmızı	<a href="http://www.wago.com/248-501">www.wago.com/248-501</a>
	<b>Ürün no.: 248-501/000-006</b> Mini-WSB etiket kartı; kart şeklinde; not stretchable; düz; takma tipi; mavi	<a href="http://www.wago.com/248-501">www.wago.com/248-501</a>
	<b>Ürün no.: 248-501/000-007</b> Mini-WSB etiket kartı; kart şeklinde; not stretchable; düz; takma tipi; gri	<a href="http://www.wago.com/248-501">www.wago.com/248-501</a>

Değişikliklere tabidir.

WAGO Elektronik Sanayi ve Ticaret Ltd. Şti.  
Yukarı Dudullu Mahallesi Bayraktar Bulvarı  
Cad. Hattat Sok. No. 10 | 34775 Ümraniye - İstanbul  
Tel.: +90 216 472 1133 111 | Fax: +90 216 472 9910  
Email: [info.tr@wago.com](mailto:info.tr@wago.com)

Ürünlerimizle ilgili sorularınız mı var?  
+90 216 472 1133 numaralı telefondan sizinle konuşmaktan mutluluk duyarız.



Ürün no.: 248-501/000-012  
Mini-WSB marking card; as card; not stretchable; plain; snap-on type; orange

[www.wago.com/248-501/000-012](http://www.wago.com/248-501/000-012)



Ürün no.: 248-501/000-017  
Mini-WSB etiket kartı; kart şeklinde; not stretchable; düz; takma tipi; açık yeşil

[www.wago.com/248-501/000-017](http://www.wago.com/248-501/000-017)



Ürün no.: 248-501/000-023  
Mini-WSB etiket kartı; kart şeklinde; not stretchable; düz; takma tipi; yeşil

[www.wago.com/248-501/000-023](http://www.wago.com/248-501/000-023)



Ürün no.: 248-501/000-024  
Mini-WSB etiket kartı; kart şeklinde; not stretchable; düz; takma tipi; menekşe

[www.wago.com/248-501/000-024](http://www.wago.com/248-501/000-024)



Ürün no.: 750-100  
Marker card; as a DIN A4 sheet; plain; white

[www.wago.com/750-100](http://www.wago.com/750-100)



Ürün no.: 750-103  
Group marker carrier; transparent

[www.wago.com/750-103](http://www.wago.com/750-103)



Ürün no.: 750-106  
Group marker carrier; transparent

[www.wago.com/750-106](http://www.wago.com/750-106)

#### Carrier rail

Ürün no.: 210-112  
Steel carrier rail; 35 x 7.5 mm; 1 mm thick; 2 m long; slotted; according to EN 60715; "Hole width 25 mm

[www.wago.com/210-112](http://www.wago.com/210-112)

Ürün no.: 210-113  
Çelik taşıyıcı ray; 35 x 7,5 mm; 1 mm kalınlık; 2 m uzunluk; yuvasız; EN 60715'e göre

[www.wago.com/210-113](http://www.wago.com/210-113)

Ürün no.: 210-114  
Steel carrier rail; 35 x 15 mm; 1.5 mm thick; 2 m long; unslotted; similar to EN 60715

[www.wago.com/210-114](http://www.wago.com/210-114)

Ürün no.: 210-115  
Çelik taşıyıcı ray; 35 x 7,5 mm; 1 mm kalınlık; 2 m uzunluk; yuvalı; EN 60715'e göre; "Delik genişliği 18 mm

[www.wago.com/210-115](http://www.wago.com/210-115)

Ürün no.: 210-118  
Çelik taşıyıcı ray; 35 x 15 mm; 2,3 mm kalınlık; 2 m uzunluk; yuvasız; EN 60715'e göre

[www.wago.com/210-118](http://www.wago.com/210-118)

Ürün no.: 210-196  
Alüminyum taşıyıcı ray; 35 x 8,2 mm; 1,6 mm kalınlık; 2 m uzunluk; yuvasız; EN 60715'e benzer; gümüş-renkli

[www.wago.com/210-196](http://www.wago.com/210-196)



Ürün no.: 210-197  
Çelik taşıyıcı ray; 35 x 15 mm; 1,5 mm kalınlık; 2 m uzunluk; yuvalı; EN 60715'e benzer

[www.wago.com/210-197](http://www.wago.com/210-197)



Ürün no.: 210-198  
Copper carrier rail; 35 x 15 mm; 2.3 mm thick; 2 m long; unslotted; according to EN 60715; copper-colored

[www.wago.com/210-198](http://www.wago.com/210-198)



Ürün no.: 210-504  
Çelik taşıyıcı ray; 35 x 7,5 mm; 1 mm kalınlık; 2 m uzunluk; yuvalı; galvanize; EN 60715'e göre

















[www.wago.com/210-504](http://www.wago.com/210-504)

Değişikliklere tabidir.

WAGO Elektronik Sanayi ve Ticaret Ltd. Şti.  
Yukarı Dudullu Mahallesi Bayraktar Bulvarı  
Cad. Hattat Sok. No. 10 | 34775 Ümraniye - İstanbul  
Tel.: +90 216 472 1133 111 | Fax: +90 216 472 9910  
Email: [info.tr@wago.com](mailto:info.tr@wago.com)

Ürünlerimizle ilgili sorularınız mı var?  
+90 216 472 1133 numaralı telefondan sizinle konuşmaktan mutluluk duyuyoruz.



	<b>Ürün no.: 210-505</b> Steel carrier rail; 35 x 7.5 mm; 1 mm thick; 2 m long; unslotted; galvanized; according to EN 60715	<a href="http://www.wago.com/210-505">www.wago.com/210-505</a>
	<b>Ürün no.: 210-506</b> Steel carrier rail; 35 x 15 mm; 1.5 mm thick; 2 m long; unslotted; galvanized; similar to EN 60715	<a href="http://www.wago.com/210-506">www.wago.com/210-506</a>
	<b>Ürün no.: 210-508</b> Steel carrier rail; 35 x 15 mm; 1.5 mm thick; 2 m long; slotted; galvanized; similar to EN 60715	<a href="http://www.wago.com/210-508">www.wago.com/210-508</a>
<b>shield connection</b>		
	<b>Ürün no.: 790-108</b> Blendaj sıkıştırma yuvası; 11 mm genişlik; uyumlu iletken çapı; 3 ... 8 mm	<a href="http://www.wago.com/790-108">www.wago.com/790-108</a>
	<b>Ürün no.: 790-116</b> Shield clamping saddle; 19 mm wide; diameter of compatible conductor; 7 ... 16 mm	<a href="http://www.wago.com/790-116">www.wago.com/790-116</a>
	<b>Ürün no.: 790-124</b> Blendaj sıkıştırma yuvası; 27 mm genişlik; uyumlu iletken çapı; 6 ... 24 mm	<a href="http://www.wago.com/790-124">www.wago.com/790-124</a>
	<b>Ürün no.: 790-140</b> Shield clamping saddle; diameter of compatible conductor	<a href="http://www.wago.com/790-140">www.wago.com/790-140</a>
	<b>Ürün no.: 790-208</b> Shield clamping saddle; 12.4 mm wide; 3 ... 8 mm	<a href="http://www.wago.com/790-208">www.wago.com/790-208</a>
	<b>Ürün no.: 790-216</b> Blendaj sıkıştırma yuvası; 21,8 mm genişlik; 6 ... 16 mm	<a href="http://www.wago.com/790-216">www.wago.com/790-216</a>
	<b>Ürün no.: 790-220</b> Shield clamping saddle; 30 mm wide; 6 ... 20 mm	<a href="http://www.wago.com/790-220">www.wago.com/790-220</a>
<b>system box</b>		
	<b>Ürün no.: 850-804</b> IP65 gövde; Paslanmaz çelik; G x Y x D (400 x 123 x 200 mm); 4 x M20, 16 x M16, 28 x M12 kablo çorabı	<a href="http://www.wago.com/850-804">www.wago.com/850-804</a>
	<b>Ürün no.: 850-804/000-001</b> IP65 gövde; Paslanmaz çelik; G x Y x D (400 x 123 x 200 mm); 2 x M20, 13 x M16, 32 x M12 kablo çorabı	<a href="http://www.wago.com/850-804/000-001">www.wago.com/850-804/000-001</a>
	<b>Ürün no.: 850-805</b> IP65 gövde; Paslanmaz çelik; G x Y x D (600 x 123 x 200 mm); 4 x M20, 19 x M16, 67 x M12 kablo çorabı	<a href="http://www.wago.com/850-805">www.wago.com/850-805</a>
	<b>Ürün no.: 850-814/002-000</b> IP65 gövde; Çelik sac (RAL 7035); G x Y x D (200 x 120 x 200 mm); flanş plakasız	<a href="http://www.wago.com/850-814/002-000">www.wago.com/850-814/002-000</a>
	<b>Ürün no.: 850-815/002-000</b> IP65 gövde; Çelik sac (RAL 7035); G x Y x D (300 x 120 x 200 mm); flanş plakasız	<a href="http://www.wago.com/850-815/002-000">www.wago.com/850-815/002-000</a>
	<b>Ürün no.: 850-816/002-000</b> IP65 enclosure; Sheet steel (RAL 7035); WxHxD (400x120x200 mm); without flange plate	<a href="http://www.wago.com/850-816/002-000">www.wago.com/850-816/002-000</a>

Değişikliklere tabidir.

	<b>Ürün no.: 850-817/002-000</b> IP65 enclosure; Sheet steel (RAL 7035); WxHxD (600x120x200 mm); without flange plate	<a href="http://www.wago.com/850-817/002-000">www.wago.com/850-817/002-000</a>
	<b>Ürün no.: 850-825</b> IP65 gövde; Alüminyum (RAL 7032); G x Y x D (160 x 100 x 160 mm); 9 x M12, 4 x M20	<a href="http://www.wago.com/850-825">www.wago.com/850-825</a>
	<b>Ürün no.: 850-826</b> IP65 gövde; Alüminyum (RAL 7032); G x Y x D (240 x 100 x 160 mm); 4 x M20, 4 x M16, 14 x M12 kablo çorabı	<a href="http://www.wago.com/850-826">www.wago.com/850-826</a>
	<b>Ürün no.: 850-826/002-000</b> IP65 gövde; Alüminyum (RAL 7035); G x Y x D (240 x 100 x 160 mm); 4 x M20, 4 x M16, 14 x M12 kablo çorabı	<a href="http://www.wago.com/850-826/002-000">www.wago.com/850-826/002-000</a>
	<b>Ürün no.: 850-827</b> IP65 enclosure; Aluminium (RAL 7032); WxHxD (320x100x160 mm); 4 x M20, 8 x M16, 17 x M12 cable grip	<a href="http://www.wago.com/850-827">www.wago.com/850-827</a>
	<b>Ürün no.: 850-827/002-000</b> IP65 gövde; Alüminyum (RAL 7035); G x Y x D (320 x 100 x 160 mm); 4 x M20, 8 x M16, 17 x M12 kablo çorabı	<a href="http://www.wago.com/850-827/002-000">www.wago.com/850-827/002-000</a>
	<b>Ürün no.: 850-828</b> IP65 gövde; Alüminyum (RAL 7032); G x Y x D (480 x 100 x 160 mm); 4 x M20, 10 x M16, 35 x M12 kablo çorabı	<a href="http://www.wago.com/850-828">www.wago.com/850-828</a>
	<b>Ürün no.: 850-828/002-000</b> IP65 gövde; Alüminyum (RAL 7035); G x Y x D (480 x 100 x 160 mm); 4 x M20, 10 x M16, 35 x M12 kablo çorabı	<a href="http://www.wago.com/850-828/002-000">www.wago.com/850-828/002-000</a>
	<b>Ürün no.: 850-834</b> IP65 gövde; Polyester (RAL 7032); G x Y x D (164 x 100 x 164 mm); 9 x M12, 4 x M20	<a href="http://www.wago.com/850-834">www.wago.com/850-834</a>
	<b>Ürün no.: 850-835</b> IP65 enclosure; Polyester (RAL 7032); WxHxD (244x100x164 mm); 4 x M20, 4 x M16, 14 x M12 cable grip	<a href="http://www.wago.com/850-835">www.wago.com/850-835</a>
	<b>Ürün no.: 850-836</b> IP65 gövde; Polyester (RAL 7032); G x Y x D (324 x 100 x 164 mm); 4 x M20, 8 x M16, 17 x M12 kablo çorabı	<a href="http://www.wago.com/850-836">www.wago.com/850-836</a>

## Dosya İndirme

### Documentation

<b>Manual</b>			
2-channel, 4-20mA, single-ended 16 bits	V 1.1.0	pdf 2,1 MB	İndir
<b>Additional Information</b>			
Disposal; Electrical and electronic equipment, Packaging	V 1.0.0	pdf 265,8 kB	İndir

Değişikliklere tabidir.

WAGO Elektronik Sanayi ve Ticaret Ltd. Şti.  
Yukarı Dudullu Mahallesi Bayraktar Bulvarı  
Cad. Hattat Sok. No. 10 | 34775 Ümraniye - İstanbul  
Tel.: +90 216 472 1133 111 | Fax: +90 216 472 9910  
Email: [info.tr@wago.com](mailto:info.tr@wago.com)

Ürünlerimizle ilgili sorularınız mı var?  
+90 216 472 1133 numaralı telefondan sizinle konuşmaktan mutluluk duyuyoruz.



## System Description

Design Notes Basic conditions and recommendations for higher operational safety	V 2.0.0	pdf 1,5 MB	İndir
Use in Hazardous Environments Term definition, marking and installation regulations	V 1.0.0	pdf 1,0 MB	İndir
Overview on WAGO-I/O-SYSTEM 750 approvals		pdf 780,2 kB	İndir
750/753 Series I/O-System – General Product Information		pdf 1,7 MB	İndir

## CAD/CAE-Data

### CAD data

2D/3D Models 750-474		URL	İndir
----------------------	--	-----	-------

### CAE data

EPLAN Data Portal 750-474		URL	İndir
WSCAD Universe 750-474		URL	İndir

## Device Files

### Device Driver

WAGO USB Service Kabel Treiber / Serie 750 und 857	6.5.3.0 10.Eyl.2014	zip 4,8 MB	İndir
--	------------------------	---------------	-------

## Installation Notes

## Ürün ailesi

**750/753 Series – I/O System**  
[Show all products from the family](#)

Değişikliklere tabidir.

WAGO Elektronik Sanayi ve Ticaret Ltd. Şti.  
Yukarı Dudullu Mahallesi Bayraktar Bulvarı  
Cad. Hattat Sok. No. 10 | 34775 Ümraniye - İstanbul  
Tel.: +90 216 472 1133 111 | Fax: +90 216 472 9910  
Email: [info.tr@wago.com](mailto:info.tr@wago.com)

Ürünlerimizle ilgili sorularınız mı var?  
+90 216 472 1133 numaralı telefondan sizinle konuşmaktan mutluluk  
duyarız.