

Veri sayfası | Ürün numarası: 750-468

4 kanallı analog giriş; 0 ... 10 VDC; Tek uçlu; açık gri

www.wago.com/750-468

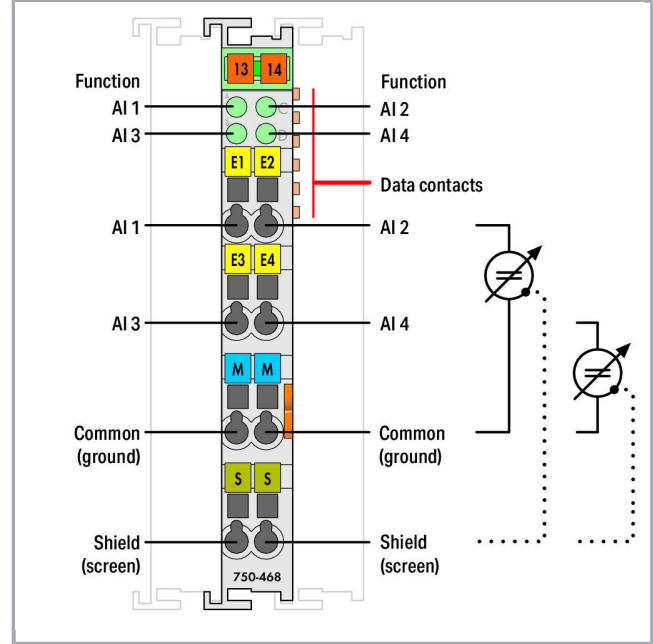

RoHS Compliant

BOMcheck.net

Renk: ■

Değişikliklere tabidir.

WAGO Elektronik Sanayi ve Ticaret Ltd. Şti.
Yukarı Dudullu Mahallesi Bayraktar Bulvarı
Cad. Hattat Sok. No. 10 | 34775 Ümraniye - İstanbul
Tel.: +90 216 472 1133 111 | Fax: +90 216 472 9910
Email: info.tr@wago.com

Ürünlerimizle ilgili sorularınız mı var?
+90 216 472 1133 numaralı telefondan sizinle konuşmaktan mutluluk duyarız.

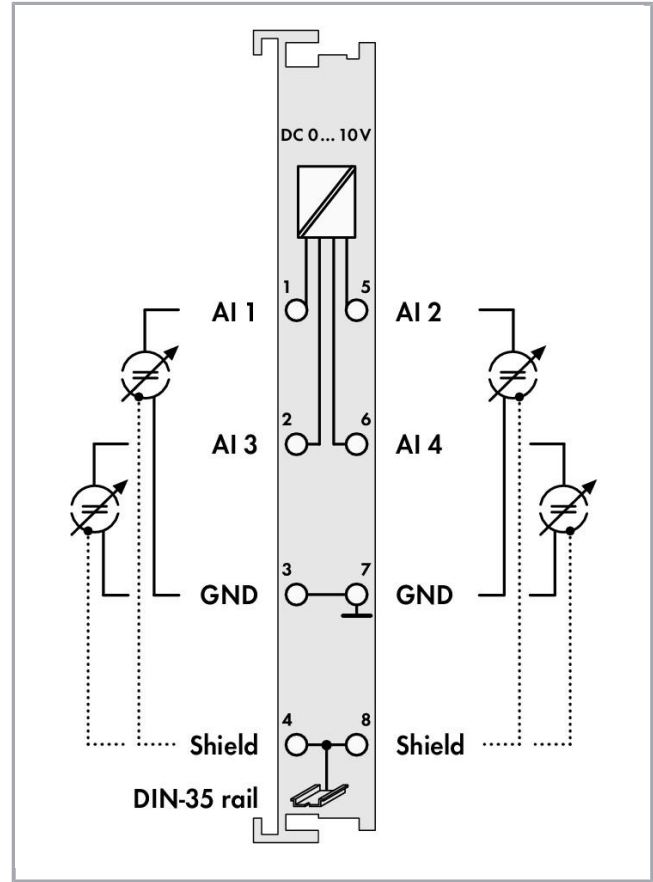
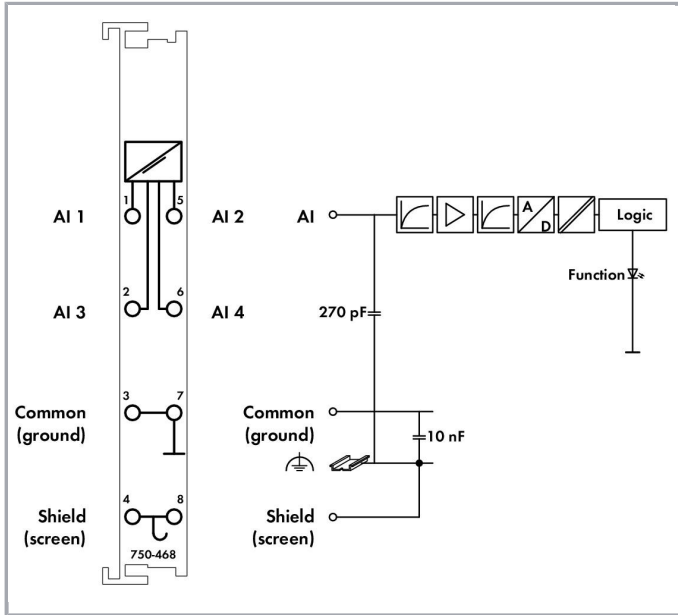

Ürün tanımı

Analog giriş modülü standartlaştırılmış 0-10V değerli sinyalleri alır.

Giriş sinyali elektriksel olarak yalıtılmış olup 12 bit çözünürlükte iletilir.

Modül, dahili sistem gerilim beslemesi tarafından beslenir.

Modül giriş kanalları bir adet ortak toprak potansiyeline sahiptir.

Blendaj (ekran) doğrudan DIN raya bağlıdır.

Veri

Technical Data

Number of analog inputs	4
Total number of channels (module)	4
Sinyal tipi	Voltage
Type of signal voltage	DC 0 ... 10 V

Değişikliklere tabidir.

WAGO Elektronik Sanayi ve Ticaret Ltd. Şti.
Yukarı Dudullu Mahallesi Bayraktar Bulvarı
Cad. Hattat Sok. No. 10 | 34775 Ümraniye - İstanbul
Tel.: +90 216 472 1133 111 | Fax: +90 216 472 9910
Email: info.tr@wago.com

Ürünlerimizle ilgili sorularınız mı var?
+90 216 472 1133 numaralı telefondan sizinle konuşmaktan mutluluk duyuyoruz.



Sensor connection	4 x (2-conductor)
Giriş gerilimi (maks.)	35 V
Signal characteristic	Single-ended
Çözünürlük [bit]	12 Bit
Bit genişliği	4 x 16 bit veri 4 x 8 bit kontrol/durum (isteğe bağlı)
Internal resistance	133 kΩ
Çevirme süresi (tip.)	4 ms
Messfehler, Bezugstemperatur	25 °C
Messfehler, Abweichung max. vom Messbereichsendwert	0,2 %
Temperaturfehler max. vom Messbereichsendwert	0,01 %/K
System supply voltage	DC 5 V; via data contacts
Current consumption, system supply (5 V)	60 mA
İzolasyon	500 V sistem/besleme

Bağlantı verisi

Connection technology: In-/Outputs	8 x CAGE CLAMP®
Connection type (1)	Inputs/Outputs
Tek damarlı boylar	0,08 ... 2,5 mm ² / 28 ... 14 AWG
İnce bükümlü kablolar	0,08 ... 2,5 mm ² / 28 ... 14 AWG
Sıyırma uzunluğu	8 ... 9 mm / 0.31 ... 0.35 inch

Geometrical Data

Width	12 mm / 0.472 inch
Height	69,8 mm / 2.748 inch
DIN rayın üst kenarından yükseklik	62,6 mm / 2.465 inch
Depth	100 mm / 3.937 inch

Mekanik Veri

Montaj tipi	DIN 35 ray
-------------	------------

Material Data

Renk	light gray
Gövde malzemesi	Polycarbonate, polyamide 6.6
Ağırlık	50 g
Uygunluk işareti	CE

Değişikliklere tabidir.

Environmental Requirements



Surrounding air (operating) temperature	0 ... 55 °C
Surrounding air (storage) temperature	-40 ... 85 °C
Koruma sınıfı	IP20
Kirlilik derecesi (5)	2 per IEC 61131-2
Çalışma yüksekliği	0 ... 2000 m
Montaj pozisyonu	horizontal (standing/lying) or vertical
Nisbi nem (yoğuşmasız)	95 %
Titreşime dayanıklı	4g per IEC 60068-2-6
Darbe direnci	15g per IEC 60068-2-27
EMC immunity to interference	acc. to EN 61000-6-2, marine applications
EMU: 1 - enterferans emisyonu	acc. to EN 61000-6-4, marine applications
Kirletici maddelere maruziyet	Per IEC 60068-2-42 and IEC 60068-2-43
Permissible H ₂ S contaminant concentration at a relative humidity 75 %	10 ppm
Permissible SO ₂ contaminant concentration at a relative humidity 75 %	25 ppm

Ticari Veri

Product Group	15 (Remote I/O)
SAP'den ambalaj tipi	BOX
Country of origin	DE
GTIN	4045454393045
Customs Tariff No.	85389099990

Onaylar / Belgeler

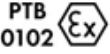
Ex Onayları

Logo	Onay	İlave Onay Metni	Belge adı
	ATEX TUEV Nord Cert GmbH	EN 60079-0	TÜV 07 ATEX 554086 X en.
	TUEV Nord TUEV Nord Cert GmbH	IEC 60079-0	IECEx TUN 09.0001 X
	UL	UL 121201	E198726

Değişikliklere tabidir.



Underwriters Laboratories Inc. (HAZARDOUS LOCATIONS)

Sec.1

Denizcilik Onayları

Logo	Onay	İlave Onay Metni	Belge adı
	KC National Radio Research Agency	Article 58-2, Clause 3	MSIP- REM- W43- AIM750

Diğer Onaylar

Logo	Onay	İlave Onay Metni	Belge adı
	ABS American Bureau of Shipping	-	19- HG1821926
	BV Bureau Veritas S.A.	-	13453/DO BV
	DNV GL Det Norske Veritas, Germanischer Lloyd	-	TAA0000194
	KR Korean Register of Shipping	-	KR HMB05880- AC001
	LR Lloyds Register	-	02/20026 (E6)
	PRS Polski Rejestr Statków	-	TE/2236 /880590/19
	RINA RINA Germany GmbH	-	ELE066419XG

Değişikliklere tabidir.

WAGO Elektronik Sanayi ve Ticaret Ltd. Şti.
Yukarı Dudullu Mahallesi Bayraktar Bulvarı
Cad. Hattat Sok. No. 10 | 34775 Ümraniye - İstanbul
Tel.: +90 216 472 1133 111 | Fax: +90 216 472 9910
Email: info.tr@wago.com

Ürünlerimizle ilgili sorularınız mı var?
+90 216 472 1133 numaralı telefondan sizinle konuşmaktan mutluluk
duyarız.









UL-Approvals

Logo	Onay	İlave Onay Metni	Belge adı
	UL UL International Netherlands B.V. (ORDINARY LOCATIONS)	UL 508	E175199 Sec.1

Counterpart

Uyumlu ürünler

system box

	Ürün no.: 850-804 IP65 gövde; Paslanmaz çelik; G x Y x D (400 x 123 x 200 mm); 4 x M20, 16 x M16, 28 x M12 kablo çorabı	www.wago.com/850-804
	Ürün no.: 850-804/000-001 IP65 gövde; Paslanmaz çelik; G x Y x D (400 x 123 x 200 mm); 2 x M20, 13 x M16, 32 x M12 kablo çorabı	www.wago.com/850-804/000-001
	Ürün no.: 850-805 IP65 gövde; Paslanmaz çelik; G x Y x D (600 x 123 x 200 mm); 4 x M20, 19 x M16, 67 x M12 kablo çorabı	www.wago.com/850-805
	Ürün no.: 850-814/002-000 IP65 gövde; Çelik sac (RAL 7035); G x Y x D (200 x 120 x 200 mm); flanş plakasız	www.wago.com/850-814/002-000
	Ürün no.: 850-815/002-000 IP65 gövde; Çelik sac (RAL 7035); G x Y x D (300 x 120 x 200 mm); flanş plakasız	www.wago.com/850-815/002-000
	Ürün no.: 850-816/002-000 IP65 enclosure; Sheet steel (RAL 7035); WxHxD (400x120x200 mm); without flange plate	www.wago.com/850-816/002-000
	Ürün no.: 850-817/002-000 IP65 enclosure; Sheet steel (RAL 7035); WxHxD (600x120x200 mm); without flange plate	www.wago.com/850-817/002-000
	Ürün no.: 850-825 IP65 gövde; Alüminyum (RAL 7032); G x Y x D (160 x 100 x 160 mm); 9 x M12, 4 x M20	www.wago.com/850-825
	Ürün no.: 850-826	

Değişikliklere tabidir.

WAGO Elektronik Sanayi ve Ticaret Ltd. Şti.
Yukarı Dudullu Mahallesi Bayraktar Bulvarı
Cad. Hattat Sok. No. 10 | 34775 Ümraniye - İstanbul
Tel.: +90 216 472 1133 111 | Fax: +90 216 472 9910
Email: info.tr@wago.com

Ürünlerimizle ilgili sorularınız mı var?
+90 216 472 1133 numaralı telefondan sizinle konuşmaktan mutluluk duyuyoruz.



IP65 gövde; Alüminyum (RAL 7032); G x Y x D (240 x 100 x 160 mm); 4 x M20, 4 x M16, 14 x M12 kablo çorabı

www.wago.com/850-826



Ürün no.: 850-826/002-000

IP65 gövde; Alüminyum (RAL 7035); G x Y x D (240 x 100 x 160 mm); 4 x M20, 4 x M16, 14 x M12 kablo çorabı

www.wago.com/850-826/002-000



Ürün no.: 850-827

IP65 enclosure; Aluminium (RAL 7032); WxHxD (320x100x160 mm); 4 x M20, 8 x M16, 17 x M12 cable grip

www.wago.com/850-827



Ürün no.: 850-827/002-000

IP65 gövde; Alüminyum (RAL 7035); G x Y x D (320 x 100 x 160 mm); 4 x M20, 8 x M16, 17 x M12 kablo çorabı

www.wago.com/850-827/002-000



Ürün no.: 850-828

IP65 gövde; Alüminyum (RAL 7032); G x Y x D (480 x 100 x 160 mm); 4 x M20, 10 x M16, 35 x M12 kablo çorabı

www.wago.com/850-828



Ürün no.: 850-828/002-000

IP65 gövde; Alüminyum (RAL 7035); G x Y x D (480 x 100 x 160 mm); 4 x M20, 10 x M16, 35 x M12 kablo çorabı

www.wago.com/850-828/002-000



Ürün no.: 850-834

IP65 gövde; Polyester (RAL 7032); G x Y x D (164 x 100 x 164 mm); 9 x M12, 4 x M20

www.wago.com/850-834



Ürün no.: 850-835

IP65 enclosure; Polyester (RAL 7032); WxHxD (244x100x164 mm); 4 x M20, 4 x M16, 14 x M12 cable grip

www.wago.com/850-835



Ürün no.: 850-836

IP65 gövde; Polyester (RAL 7032); G x Y x D (324 x 100 x 164 mm); 4 x M20, 8 x M16, 17 x M12 kablo çorabı

www.wago.com/850-836

Marking accessories



Ürün no.: 2009-145

Mini-WSB Inline; for Smart Printer; 1700 pieces on roll; stretchable 5 - 5.2 mm; plain; snap-on type; white

www.wago.com/2009-145



Ürün no.: 2009-145/000-002

Mini-WSB Inline; for Smart Printer; 1700 pieces on roll; stretchable 5 - 5.2 mm; plain; snap-on type; white /000-002

www.wago.com/2009-145/000-002



Ürün no.: 2009-145/000-005

Mini-WSB Inline; for Smart Printer; 1700 pieces on roll; stretchable 5 - 5.2 mm; plain; snap-on type; red /000-005

www.wago.com/2009-145/000-005



Ürün no.: 2009-145/000-006

Mini-WSB Inline; for Smart Printer; 1700 pieces on roll; stretchable 5 - 5.2 mm; plain; snap-on type; blue /000-006

www.wago.com/2009-145/000-006



Ürün no.: 2009-145/000-007

Mini-WSB Inline; for Smart Printer; 1700 pieces on roll; stretchable 5 - 5.2 mm; plain; snap-on type; white /000-007

www.wago.com/2009-145/000-007















Ürün no.: 2009-145/000-012

Değişikliklere tabidir.

WAGO Elektronik Sanayi ve Ticaret Ltd. Şti.
Yukarı Dudullu Mahallesi Bayraktar Bulvarı
Cad. Hattat Sok. No. 10 | 34775 Ümraniye - İstanbul
Tel.: +90 216 472 1133 111 | Fax: +90 216 472 9910
Email: info.tr@wago.com

Ürünlerimizle ilgili sorularınız mı var?

+90 216 472 1133 numaralı telefondan sizinle konuşmaktan mutluluk duyarız.

	Mini-WSB Inline; for Smart Printer; 1700 pieces on roll; stretchable 5 - 5.2 mm; plain; snap-on type; orange	www.wago.com/2009-145/000-012
	Ürün no.: 2009-145/000-023 Mini-WSB Inline; for Smart Printer; 1700 pieces on roll; stretchable 5 - 5.2 mm; plain; snap-on type; green	www.wago.com/2009-145/000-023
	Ürün no.: 2009-145/000-024 Mini-WSB Inline; for Smart Printer; 1700 pieces on roll; stretchable 5 - 5.2 mm; plain; snap-on type; violet	www.wago.com/2009-145/000-024
	Ürün no.: 248-501 Minyatür WSB Hızlı etiketleme sistemi; düz; Etiket genişliği 5 mm; her kartta 10 etiketli 10 şerit	www.wago.com/248-501
	Ürün no.: 248-501/000-002 Mini-WSB etiket kartı; kart şeklinde; not stretchable; düz; takma tipi; sarı	www.wago.com/248-501/000-002
	Ürün no.: 248-501/000-005 Mini-WSB etiket kartı; kart şeklinde; not stretchable; düz; takma tipi; kırmızı	www.wago.com/248-501/000-005
	Ürün no.: 248-501/000-006 Mini-WSB etiket kartı; kart şeklinde; not stretchable; düz; takma tipi; mavi	www.wago.com/248-501/000-006
	Ürün no.: 248-501/000-007 Mini-WSB etiket kartı; kart şeklinde; not stretchable; düz; takma tipi; gri	www.wago.com/248-501/000-007
	Ürün no.: 248-501/000-012 Mini-WSB marking card; as card; not stretchable; plain; snap-on type; orange	www.wago.com/248-501/000-012
	Ürün no.: 248-501/000-017 Mini-WSB etiket kartı; kart şeklinde; not stretchable; düz; takma tipi; açık yeşil	www.wago.com/248-501/000-017
	Ürün no.: 248-501/000-023 Mini-WSB etiket kartı; kart şeklinde; not stretchable; düz; takma tipi; yeşil	www.wago.com/248-501/000-023
	Ürün no.: 248-501/000-024 Mini-WSB etiket kartı; kart şeklinde; not stretchable; düz; takma tipi; menekşe	www.wago.com/248-501/000-024
	Ürün no.: 750-100 Marker card; as a DIN A4 sheet; plain; white	www.wago.com/750-100
	Ürün no.: 750-103 Group marker carrier; transparent	www.wago.com/750-103

Değişikliklere tabidir.



Ürün no.: 750-106
Group marker carrier; transparent

www.wago.com/750-106

shield connection



Ürün no.: 790-108
Blendaj sıkıştırma yuvası; 11 mm genişlik; uyumlu iletken çapı; 3 ... 8 mm

www.wago.com/790-108



Ürün no.: 790-116
Shield clamping saddle; 19 mm wide; diameter of compatible conductor; 7 ... 16 mm

www.wago.com/790-116



Ürün no.: 790-124
Blendaj sıkıştırma yuvası; 27 mm genişlik; uyumlu iletken çapı; 6 ... 24 mm

www.wago.com/790-124



Ürün no.: 790-140
Shield clamping saddle; diameter of compatible conductor

www.wago.com/790-140



Ürün no.: 790-208
Shield clamping saddle; 12.4 mm wide; 3 ... 8 mm

www.wago.com/790-208



Ürün no.: 790-216
Blendaj sıkıştırma yuvası; 21,8 mm genişlik; 6 ... 16 mm

www.wago.com/790-216



Ürün no.: 790-220
Shield clamping saddle; 30 mm wide; 6 ... 20 mm

www.wago.com/790-220

Carrier rail



Ürün no.: 210-112
Steel carrier rail; 35 x 7.5 mm; 1 mm thick; 2 m long; slotted; according to EN 60715; "Hole width 25 mm

www.wago.com/210-112

Ürün no.: 210-113
Çelik taşıyıcı ray; 35 x 7,5 mm; 1 mm kalınlık; 2 m uzunluk; yuvasız; EN 60715'e göre

www.wago.com/210-113

Ürün no.: 210-114
Steel carrier rail; 35 x 15 mm; 1.5 mm thick; 2 m long; unslotted; similar to EN 60715

www.wago.com/210-114

Ürün no.: 210-115
Çelik taşıyıcı ray; 35 x 7,5 mm; 1 mm kalınlık; 2 m uzunluk; yuvalı; EN 60715'e göre; "Delik genişliği 18 mm

www.wago.com/210-115

Ürün no.: 210-118
Çelik taşıyıcı ray; 35 x 15 mm; 2,3 mm kalınlık; 2 m uzunluk; yuvasız; EN 60715'e göre

www.wago.com/210-118

Ürün no.: 210-196
Alüminyum taşıyıcı ray; 35 x 8,2 mm; 1,6 mm kalınlık; 2 m uzunluk; yuvasız; EN 60715'e benzer; gümüş-
renkli

www.wago.com/210-196



Ürün no.: 210-197
Çelik taşıyıcı ray; 35 x 15 mm; 1,5 mm kalınlık; 2 m uzunluk; yuvalı; EN 60715'e benzer

www.wago.com/210-197



Ürün no.: 210-198
Copper carrier rail; 35 x 15 mm; 2.3 mm thick; 2 m long; unslotted; according to EN 60715; copper-
colored

www.wago.com/210-198



Ürün no.: 210-504
Çelik taşıyıcı ray; 35 x 7,5 mm; 1 mm kalınlık; 2 m uzunluk; yuvalı; galvanize; EN 60715'e göre

www.wago.com/210-504

Değişikliklere tabidir.

WAGO Elektronik Sanayi ve Ticaret Ltd. Şti.
Yukarı Dudullu Mahallesi Bayraktar Bulvarı
Cad. Hattat Sok. No. 10 | 34775 Ümraniye - İstanbul
Tel.: +90 216 472 1133 111 | Fax: +90 216 472 9910
Email: info.tr@wago.com

Ürünlerimizle ilgili sorularınız mı var?
+90 216 472 1133 numaralı telefondan sizinle konuşmaktan mutluluk
duyarız.

**Ürün no.: 210-505**

Steel carrier rail; 35 x 7.5 mm; 1 mm thick; 2 m long; unslotted; galvanized; according to EN 60715

www.wago.com/210-505**Ürün no.: 210-506**

Steel carrier rail; 35 x 15 mm; 1.5 mm thick; 2 m long; unslotted; galvanized; similar to EN 60715

www.wago.com/210-506**Ürün no.: 210-508**

Steel carrier rail; 35 x 15 mm; 1.5 mm thick; 2 m long; slotted; galvanized; similar to EN 60715

www.wago.com/210-508

Dosya İndirme Documentation

Manual

4-channel, 0-10VDC, single-ended	V 1.3.0	pdf 2,0 MB	İndir
----------------------------------	---------	---------------	-------

Additional Information

Disposal; Electrical and electronic equipment, Packaging	V 1.0.0	pdf 265,8 kB	İndir
--	---------	-----------------	-------

System Description

Use in Hazardous Environments Term definition, marking and installation regulations	V 1.0.0	pdf 1,0 MB	İndir
--	---------	---------------	-------

750/753 Series I/O-System – General Product Information		pdf 1,7 MB	İndir
---	--	---------------	-------

Design Notes Basic conditions and recommendations for higher operational safety	V 2.0.0	pdf 1,5 MB	İndir
--	---------	---------------	-------

Overview on WAGO-I/O-SYSTEM 750 approvals		pdf 780,2 kB	İndir
---	--	-----------------	-------

CAD/CAE-Data

CAD data

2D/3D Models 750-468		URL	İndir
----------------------	--	-----	-------

CAE data

EPLAN Data Portal 750-468		URL	İndir
---------------------------	--	-----	-------

Değişikliklere tabidir.

WAGO Elektronik Sanayi ve Ticaret Ltd. Şti.
Yukarı Dudullu Mahallesi Bayraktar Bulvarı
Cad. Hattat Sok. No. 10 | 34775 Ümraniye - İstanbul
Tel.: +90 216 472 1133 111 | Fax: +90 216 472 9910
Email: info.tr@wago.com

Ürünlerimizle ilgili sorularınız mı var?
+90 216 472 1133 numaralı telefondan sizinle konuşmaktan mutluluk
duyarız.



Device Files

Device Driver

WAGO USB Service Kabel Treiber / Serie 750 und 857	6.5.3.0 10.Eyl.2014	zip 4,8 MB	İndir
--	------------------------	---------------	-------

Installation Notes

Ürün ailesi

750/753 Series – I/O System

[Show all products from the family](#)

Değişikliklere tabidir.