

Veri sayfası | Ürün numarası: 750-433

4 kanallı dijital giriş; 24 VDC; 0,2 ms; 2 iletkenli bağlantı; açık gri

www.wago.com/750-433

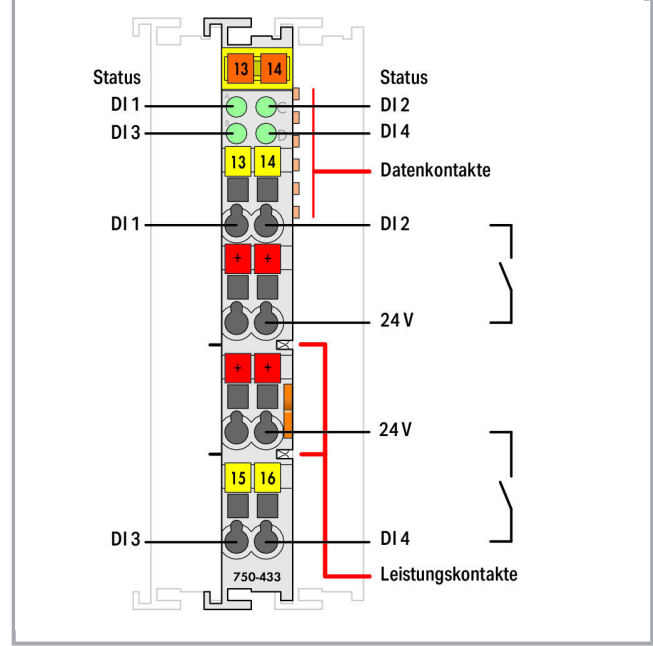

RoHS Compliant

BOMcheck.net

Renk: ■

Değişikliklere tabidir.

WAGO Elektronik Sanayi ve Ticaret Ltd. Şti.
Yukarı Dudullu Mahallesi Bayraktar Bulvarı
Cad. Hattat Sok. No. 10 | 34775 Ümraniye - İstanbul
Tel.: +90 216 472 1133 111 | Fax: +90 216 472 9910
Email: info.tr@wago.com

Ürünlerimizle ilgili sorularınız mı var?
+90 216 472 1133 numaralı telefondan sizinle konuşmaktan mutluluk duyarız.

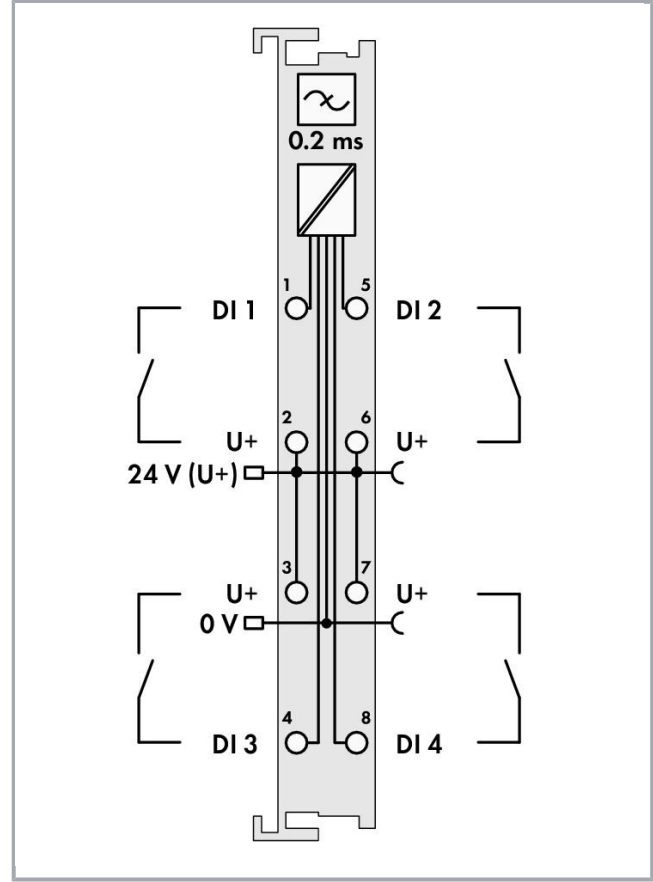
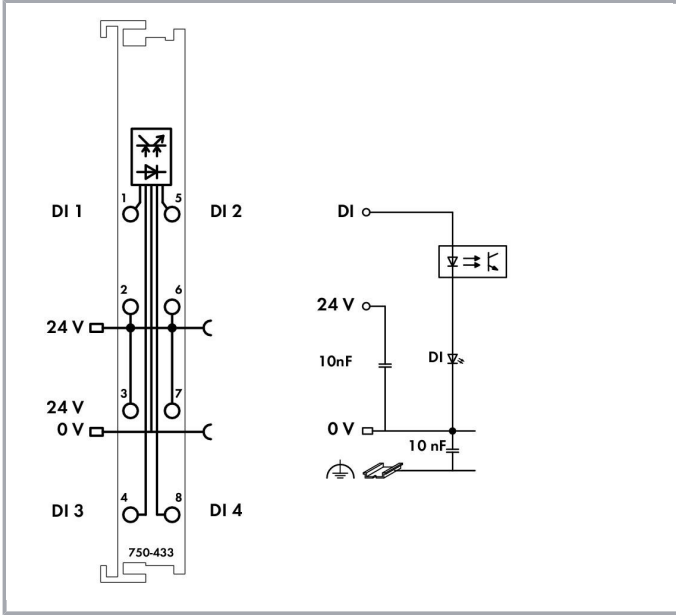

Ürün tanımı

Dijital giriş modülü dijital saha aygıtlarından gönderilen (sensörler, vb.) kontrol sinyalini alır.

Modül 4 giriş kanallı, 2 iletkenli bir aygıttır. Dört 24V bağlantısından dolayı dört sensör doğrudan bağlanabilir.

Her giriş modülünde bir gürültü bastırma filtresi bulunur. Bu filtre farklı zaman sabitleriyle kullanılabilir.

Saha ve sistem düzeyleri elektrik yalıtımlıdır.

Veri

Technical Data

Number of digital inputs	4
Total number of channels (module)	4
Sinyal tipi	Voltage
Type of signal voltage	DC 24 V
Sensor supply voltage	DC 24 V

Değişikliklere tabidir.

WAGO Elektronik Sanayi ve Ticaret Ltd. Şti.
Yukarı Dudullu Mahallesi Bayraktar Bulvarı
Cad. Hattat Sok. No. 10 | 34775 Ümraniye - İstanbul
Tel.: +90 216 472 1133 111 | Fax: +90 216 472 9910
Email: info.tr@wago.com

Ürünlerimizle ilgili sorularınız mı var?
+90 216 472 1133 numaralı telefondan sizinle konuşmaktan mutluluk duyuyoruz.



Sensor connection	4 x (2-conductor)
Input characteristic	high-side switching
Input filter (digital)	0,2 ms
Input current per channel for signal (1) typ.	4,5 mA
Sinyal gerilimi (0)	-3 ... +5 VDC
Sinyal gerilimi (1)	15 ... 30 VDC
Max input data width (internal)	4 Bit
System supply voltage	DC 5 V; via data contacts
Current consumption, system supply (5 V)	5,5 mA
Field supply voltage	DC 24 V (-25 ... +30 %); über Leistungskontakte (Einspeisung über Messerkontakt; Weiterleitung über Federkontakt)
izolasyon	500 V sistem/besleme
Indicators	LED (A-D) green: Status DI 1 ... DI 4
Number of incoming power jumper contacts	2
Number of outgoing power jumper contacts	2
Current carrying capacity of the power jumper contacts	10 A

Bağlantı verisi

Connection technology: In-/Outputs	8 x CAGE CLAMP®
Connection type (1)	Inputs/Outputs
Tek damarlı boylar	0,08 ... 2,5 mm ² / 28 ... 14 AWG
İnce bükümlü kablolar	0,08 ... 2,5 mm ² / 28 ... 14 AWG
Sıyırma uzunluğu	8 ... 9 mm / 0.31 ... 0.35 inch

Geometrical Data

Width	12 mm / 0.472 inch
Height	69,8 mm / 2.748 inch
DIN rayın üst kenarından yükseklik	62,6 mm / 2.465 inch
Depth	100 mm / 3.937 inch

Mekanik Veri

Montaj tipi	DIN 35 ray
-------------	------------

Material Data

Renk	açık gri
Gövde malzemesi	Polycarbonate, polyamide 6.6

Değişikliklere tabidir.

Yangın yükü	1,139 MJ
Ağırlık	48 g
Uygunluk işareti	CE

Environmental Requirements

Surrounding air (operating) temperature	0 ... 55 °C
Surrounding air (storage) temperature	-40 ... 85 °C
Koruma sınıfı	IP20
Kirlilik derecesi (5)	2 per IEC 61131-2
Çalışma yüksekliği	0 ... 2000 m
Montaj pozisyonu	horizontal (standing/lying) or vertical
Nisbi nem (yoğuşmasız)	95 %
Titreşime dayanıklı	4g per IEC 60068-2-6
Darbe direnci	15g per IEC 60068-2-27
EMC immunity to interference	acc. to EN 61000-6-2, marine applications
EMU: 1 - enterferans emisyonu	acc. to EN 61000-6-3, marine applications
Kirletici maddelere maruziyet	Per IEC 60068-2-42 and IEC 60068-2-43
Permissible H ₂ S contaminant concentration at a relative humidity 75 %	10 ppm
Permissible SO ₂ contaminant concentration at a relative humidity 75 %	25 ppm

Ticari Veri

Product Group	15 (Remote I/O)
SAP'den ambalaj tipi	BOX
Country of origin	DE
GTIN	4045454466183
Customs Tariff No.	85389099990

Onaylar / Belgeler

Ex Onayları

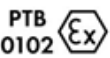
Logo	Onay	İlave Onay Metni	Belge adı
	ATEX TUEV Nord Cert GmbH	EN 60079-0	TÜV 07 ATEX 554086 X en.
	TUEV Nord	IEC 60079-0	IECEX

Değişikliklere tabidir.

WAGO Elektronik Sanayi ve Ticaret Ltd. Şti.
Yukarı Dudullu Mahallesi Bayraktar Bulvarı
Cad. Hattat Sok. No. 10 | 34775 Ümraniye - İstanbul
Tel.: +90 216 472 1133 111 | Fax: +90 216 472 9910
Email: info.tr@wago.com

Ürünlerimizle ilgili sorularınız mı var?
+90 216 472 1133 numaralı telefondan sizinle konuşmaktan mutluluk
duyarız.

TUEV Nord Cert GmbH

TUN
09.0001
XUL
Underwriters Laboratories Inc. (HAZARDOUS
LOCATIONS)

UL 121201

E198726
Sec.1

Denizcilik Onayları

Logo	Onay	İlave Onay Metni	Belge adı
	KC National Radio Research Agency	Article 58-2, Clause 3	MSIP- REM- W43- DIM750

Diğer Onaylar

Logo	Onay	İlave Onay Metni	Belge adı
	ABS American Bureau of Shipping	-	19- HG1821926
	BV Bureau Veritas S.A.	-	13453/DO BV
	DNV GL Det Norske Veritas, Germanischer Lloyd	-	TAA0000194
	KR Korean Register of Shipping	-	KR HMB05880- AC001
	LR Lloyds Register	-	02/20026 (E6)
	NK Nippon Kaiji Kyokai	-	TA17255M

Değişikliklere tabidir.

WAGO Elektronik Sanayi ve Ticaret Ltd. Şti.
Yukarı Dudullu Mahallesi Bayraktar Bulvarı
Cad. Hattat Sok. No. 10 | 34775 Ümraniye - İstanbul
Tel.: +90 216 472 1133 111 | Fax: +90 216 472 9910
Email: info.tr@wago.com

Ürünlerimizle ilgili sorularınız mı var?
+90 216 472 1133 numaralı telefondan sizinle konuşmaktan mutluluk
duyarız.



PRS
Polski Rejestr Statków

-

TE/2236
/880590/19



RINA
RINA Germany GmbH

-

ELE066419XG

UL-Approvals

Logo	Onay	İlave Onay Metni	Belge adı
	UL UL International Netherlands B.V. (ORDINARY LOCATIONS)	UL 508	E175199 Sec.1

Counterpart

Uyumlu ürünler

shield connection





	Ürün no.: 790-108 Blendaj sıkıştırma yuvası; 11 mm genişlik; uyumlu iletken çapı; 3 ... 8 mm	www.wago.com/790-108
	Ürün no.: 790-116 Shield clamping saddle; 19 mm wide; diameter of compatible conductor; 7 ... 16 mm	www.wago.com/790-116
	Ürün no.: 790-124 Blendaj sıkıştırma yuvası; 27 mm genişlik; uyumlu iletken çapı; 6 ... 24 mm	www.wago.com/790-124
	Ürün no.: 790-140 Shield clamping saddle; diameter of compatible conductor	www.wago.com/790-140
	Ürün no.: 790-208 Shield clamping saddle; 12.4 mm wide; 3 ... 8 mm	www.wago.com/790-208
	Ürün no.: 790-216 Blendaj sıkıştırma yuvası; 21,8 mm genişlik; 6 ... 16 mm	www.wago.com/790-216
	Ürün no.: 790-220 Shield clamping saddle; 30 mm wide; 6 ... 20 mm	www.wago.com/790-220

Değişikliklere tabidir.

WAGO Elektronik Sanayi ve Ticaret Ltd. Şti.
Yukarı Dudullu Mahallesi Bayraktar Bulvarı
Cad. Hattat Sok. No. 10 | 34775 Ümraniye - İstanbul
Tel.: +90 216 472 1133 111 | Fax: +90 216 472 9910
Email: info.tr@wago.com

Ürünlerimizle ilgili sorularınız mı var?
+90 216 472 1133 numaralı telefondan sizinle konuşmaktan mutluluk
duyarız.

Supply module

	Ürün no.: 750-601 Güç Kaynağı; 24 VDC; sigorta yuvası; açık gri	www.wago.com/750-601
	Ürün no.: 750-602 Güç Kaynağı; 24 VDC; açık gri	www.wago.com/750-602
	Ürün no.: 750-610 Güç Kaynağı; 24 VDC; sigorta yuvası; Arıza teşhisi	www.wago.com/750-610
	Ürün no.: 750-612 Güç Kaynağı; 0 ... 230 V AC/DC; açık gri	www.wago.com/750-612

Marking accessories

	Ürün no.: 2009-145 Mini-WSB Inline; for Smart Printer; 1700 pieces on roll; stretchable 5 - 5.2 mm; plain; snap-on type; white	www.wago.com/2009-145
	Ürün no.: 2009-145/000-002 Mini-WSB Inline; for Smart Printer; 1700 pieces on roll; stretchable 5 - 5.2 mm; plain; snap-on type; white /000-002	www.wago.com/2009-145
	Ürün no.: 2009-145/000-005 Mini-WSB Inline; for Smart Printer; 1700 pieces on roll; stretchable 5 - 5.2 mm; plain; snap-on type; red /000-005	www.wago.com/2009-145
	Ürün no.: 2009-145/000-006 Mini-WSB Inline; for Smart Printer; 1700 pieces on roll; stretchable 5 - 5.2 mm; plain; snap-on type; blue /000-006	www.wago.com/2009-145
	Ürün no.: 2009-145/000-007 Mini-WSB Inline; for Smart Printer; 1700 pieces on roll; stretchable 5 - 5.2 mm; plain; snap-on type; white /000-007	www.wago.com/2009-145
	Ürün no.: 2009-145/000-012 Mini-WSB Inline; for Smart Printer; 1700 pieces on roll; stretchable 5 - 5.2 mm; plain; snap-on type; orange	www.wago.com/2009-145
	Ürün no.: 2009-145/000-023 Mini-WSB Inline; for Smart Printer; 1700 pieces on roll; stretchable 5 - 5.2 mm; plain; snap-on type; green	www.wago.com/2009-145
	Ürün no.: 2009-145/000-024 Mini-WSB Inline; for Smart Printer; 1700 pieces on roll; stretchable 5 - 5.2 mm; plain; snap-on type; violet	www.wago.com/2009-145
	Ürün no.: 248-501 Minyatür WSB Hızlı etiketleme sistemi; düz; Etiket genişliği 5 mm; her kartta 10 etiketli 10 şerit	www.wago.com/248-501
	Ürün no.: 248-501/000-002 Mini-WSB etiket kartı; kart şeklinde; not stretchable; düz; takma tipi; sarı	www.wago.com/248-501

Değişikliklere tabidir.

WAGO Elektronik Sanayi ve Ticaret Ltd. Şti.
Yukarı Dudullu Mahallesi Bayraktar Bulvarı
Cad. Hattat Sok. No. 10 | 34775 Ümraniye - İstanbul
Tel.: +90 216 472 1133 111 | Fax: +90 216 472 9910
Email: info.tr@wago.com

Ürünlerimizle ilgili sorularınız mı var?
+90 216 472 1133 numaralı telefondan sizinle konuşmaktan mutluluk duyuyoruz.



Ürün no.: 248-501/000-005
Mini-WSB etiket kartı; kart şeklinde; not stretchable; düz; takma tipi; kırmızı

www.wago.com/248-501/000-005



Ürün no.: 248-501/000-006
Mini-WSB etiket kartı; kart şeklinde; not stretchable; düz; takma tipi; mavi

www.wago.com/248-501/000-006



Ürün no.: 248-501/000-007
Mini-WSB etiket kartı; kart şeklinde; not stretchable; düz; takma tipi; gri

www.wago.com/248-501/000-007



Ürün no.: 248-501/000-012
Mini-WSB marking card; as card; not stretchable; plain; snap-on type; orange

www.wago.com/248-501/000-012



Ürün no.: 248-501/000-017
Mini-WSB etiket kartı; kart şeklinde; not stretchable; düz; takma tipi; açık yeşil

www.wago.com/248-501/000-017



Ürün no.: 248-501/000-023
Mini-WSB etiket kartı; kart şeklinde; not stretchable; düz; takma tipi; yeşil

www.wago.com/248-501/000-023



Ürün no.: 248-501/000-024
Mini-WSB etiket kartı; kart şeklinde; not stretchable; düz; takma tipi; menekşe

www.wago.com/248-501/000-024



Ürün no.: 750-100
Marker card; as a DIN A4 sheet; plain; white

www.wago.com/750-100



Ürün no.: 750-103
Group marker carrier; transparent

www.wago.com/750-103



Ürün no.: 750-106
Group marker carrier; transparent

www.wago.com/750-106

Carrier rail



Ürün no.: 210-112
Steel carrier rail; 35 x 7.5 mm; 1 mm thick; 2 m long; slotted; according to EN 60715; "Hole width 25 mm

www.wago.com/210-112



Ürün no.: 210-113
Çelik taşıyıcı ray; 35 x 7,5 mm; 1 mm kalınlık; 2 m uzunluk; yuvasız; EN 60715'e göre

www.wago.com/210-113



Ürün no.: 210-114
Steel carrier rail; 35 x 15 mm; 1.5 mm thick; 2 m long; unslotted; similar to EN 60715

www.wago.com/210-114



Ürün no.: 210-115
Çelik taşıyıcı ray; 35 x 7,5 mm; 1 mm kalınlık; 2 m uzunluk; yuvalı; EN 60715'e göre; "Delik genişliği 18 mm

www.wago.com/210-115

















Ürün no.: 210-118
Çelik taşıyıcı ray; 35 x 15 mm; 2,3 mm kalınlık; 2 m uzunluk; yuvasız; EN 60715'e göre

www.wago.com/210-118

Ürün no.: 210-196









Değişikliklere tabidir.

	Alüminyum taşıyıcı ray; 35 x 8,2 mm; 1,6 mm kalınlık; 2 m uzunluk; yuvasız; EN 60715'e benzer; gümüş-renkli	www.wago.com/210-196
	Ürün no.: 210-197 Çelik taşıyıcı ray; 35 x 15 mm; 1,5 mm kalınlık; 2 m uzunluk; yuvalı; EN 60715'e benzer	www.wago.com/210-197
	Ürün no.: 210-198 Copper carrier rail; 35 x 15 mm; 2.3 mm thick; 2 m long; unslotted; according to EN 60715; copper-colored	www.wago.com/210-198
	Ürün no.: 210-504 Çelik taşıyıcı ray; 35 x 7,5 mm; 1 mm kalınlık; 2 m uzunluk; yuvalı; galvanize; EN 60715'e göre	www.wago.com/210-504
	Ürün no.: 210-505 Steel carrier rail; 35 x 7.5 mm; 1 mm thick; 2 m long; unslotted; galvanized; according to EN 60715	www.wago.com/210-505
	Ürün no.: 210-506 Steel carrier rail; 35 x 15 mm; 1.5 mm thick; 2 m long; unslotted; galvanized; similar to EN 60715	www.wago.com/210-506
	Ürün no.: 210-508 Steel carrier rail; 35 x 15 mm; 1.5 mm thick; 2 m long; slotted; galvanized; similar to EN 60715	www.wago.com/210-508
system box		
	Ürün no.: 850-804 IP65 gövde; Paslanmaz çelik; G x Y x D (400 x 123 x 200 mm); 4 x M20, 16 x M16, 28 x M12 kablo çorabı	www.wago.com/850-804
	Ürün no.: 850-804/000-001 IP65 gövde; Paslanmaz çelik; G x Y x D (400 x 123 x 200 mm); 2 x M20, 13 x M16, 32 x M12 kablo çorabı	www.wago.com/850-804/000-001
	Ürün no.: 850-805 IP65 gövde; Paslanmaz çelik; G x Y x D (600 x 123 x 200 mm); 4 x M20, 19 x M16, 67 x M12 kablo çorabı	www.wago.com/850-805
	Ürün no.: 850-814/002-000 IP65 gövde; Çelik sac (RAL 7035); G x Y x D (200 x 120 x 200 mm); flanş plakasız	www.wago.com/850-814/002-000
	Ürün no.: 850-815/002-000 IP65 gövde; Çelik sac (RAL 7035); G x Y x D (300 x 120 x 200 mm); flanş plakasız	www.wago.com/850-815/002-000
	Ürün no.: 850-816/002-000 IP65 enclosure; Sheet steel (RAL 7035); WxHxD (400x120x200 mm); without flange plate	www.wago.com/850-816/002-000
	Ürün no.: 850-817/002-000 IP65 enclosure; Sheet steel (RAL 7035); WxHxD (600x120x200 mm); without flange plate	www.wago.com/850-817/002-000
	Ürün no.: 850-825 IP65 gövde; Alüminyum (RAL 7032); G x Y x D (160 x 100 x 160 mm); 9 x M12, 4 x M20	www.wago.com/850-825
	Ürün no.: 850-826 IP65 gövde; Alüminyum (RAL 7032); G x Y x D (240 x 100 x 160 mm); 4 x M20, 4 x M16, 14 x M12 kablo	www.wago.com/850-826

Değişikliklere tabidir.

WAGO Elektronik Sanayi ve Ticaret Ltd. Şti.
Yukarı Dudullu Mahallesi Bayraktar Bulvarı
Cad. Hattat Sok. No. 10 | 34775 Ümraniye - İstanbul
Tel.: +90 216 472 1133 111 | Fax: +90 216 472 9910
Email: info.tr@wago.com

Ürünlerimizle ilgili sorularınız mı var?
+90 216 472 1133 numaralı telefondan sizinle konuşmaktan mutluluk duyarız.

	çorabı		
	Ürün no.: 850-826/002-000 IP65 gövde; Alüminyum (RAL 7035); G x Y x D (240 x 100 x 160 mm); 4 x M20, 4 x M16, 14 x M12 kablo çorabı		www.wago.com/850-826/002-000
	Ürün no.: 850-827 IP65 enclosure; Aluminium (RAL 7032); WxHxD (320x100x160 mm); 4 x M20, 8 x M16, 17 x M12 cable grip		www.wago.com/850-827
	Ürün no.: 850-827/002-000 IP65 gövde; Alüminyum (RAL 7035); G x Y x D (320 x 100 x 160 mm); 4 x M20, 8 x M16, 17 x M12 kablo çorabı		www.wago.com/850-827/002-000
	Ürün no.: 850-828 IP65 gövde; Alüminyum (RAL 7032); G x Y x D (480 x 100 x 160 mm); 4 x M20, 10 x M16, 35 x M12 kablo çorabı		www.wago.com/850-828
	Ürün no.: 850-828/002-000 IP65 gövde; Alüminyum (RAL 7035); G x Y x D (480 x 100 x 160 mm); 4 x M20, 10 x M16, 35 x M12 kablo çorabı		www.wago.com/850-828/002-000
	Ürün no.: 850-834 IP65 gövde; Polyester (RAL 7032); G x Y x D (164 x 100 x 164 mm); 9 x M12, 4 x M20		www.wago.com/850-834
	Ürün no.: 850-835 IP65 enclosure; Polyester (RAL 7032); WxHxD (244x100x164 mm); 4 x M20, 4 x M16, 14 x M12 cable grip		www.wago.com/850-835
	Ürün no.: 850-836 IP65 gövde; Polyester (RAL 7032); G x Y x D (324 x 100 x 164 mm); 4 x M20, 8 x M16, 17 x M12 kablo çorabı		www.wago.com/850-836

Dosya İndirme

Documentation

Manual			
4-channel, 24VDC, 0.2ms 2-wire connection; high-side switching	V 1.1.0	pdf 793,9 kB	İndir
Additional Information			
Disposal; Electrical and electronic equipment, Packaging	V 1.0.0	pdf 265,8 kB	İndir
System Description			
750/753 Series I/O-System – General Product Information		pdf 1,7 MB	İndir

Overview on WAGO-I/O-SYSTEM 750 approvals

Değişikliklere tabidir.

WAGO Elektronik Sanayi ve Ticaret Ltd. Şti.
Yukarı Dudullu Mahallesi Bayraktar Bulvarı
Cad. Hattat Sok. No. 10 | 34775 Ümraniye - İstanbul
Tel.: +90 216 472 1133 111 | Fax: +90 216 472 9910
Email: info.tr@wago.com

Ürünlerimizle ilgili sorularınız mı var?
+90 216 472 1133 numaralı telefondan sizinle konuşmaktan mutluluk duyarız.



		pdf 780,2 kB	İndir
Design Notes Basic conditions and recommendations for higher operational safety	V 2.0.0	pdf 1,5 MB	İndir
Use in Hazardous Environments Term definition, marking and installation regulations	V 1.0.0	pdf 1,0 MB	İndir

CAD/CAE-Data

CAD data

2D/3D Models 750-433	URL	İndir
----------------------	-----	-------

CAE data

EPLAN Data Portal 750-433	URL	İndir
---------------------------	-----	-------

WSCAD Universe 750-433	URL	İndir
------------------------	-----	-------

Device Files

Device Driver

WAGO USB Service Kabel Treiber / Serie 750 und 857	6.5.3.0 10.Eyl.2014	zip 4,8 MB	İndir
--	------------------------	---------------	-------

Installation Notes

Ürün ailesi

750/753 Series – I/O System

[Show all products from the family](#)

Değişikliklere tabidir.

WAGO Elektronik Sanayi ve Ticaret Ltd. Şti.
Yukarı Dudullu Mahallesi Bayraktar Bulvarı
Cad. Hattat Sok. No. 10 | 34775 Ümraniye - İstanbul
Tel.: +90 216 472 1133 111 | Fax: +90 216 472 9910
Email: info.tr@wago.com

Ürünlerimizle ilgili sorularınız mı var?
+90 216 472 1133 numaralı telefondan sizinle konuşmaktan mutluluk
duyarız.