



Model Number

RL28-55-LAS/47/82b/105

Retroreflective sensor
with 5-pin, M12 x 1 plastic connector

Features

- Visible red light, pulsed LASER light
- Ultra bright LEDs for power on, weak signal indication and switching state
- Not sensitive to ambient light, even with switched energy saving lamps
- Protection class II
- Waterproof, degree of protection IP67

Dimensions

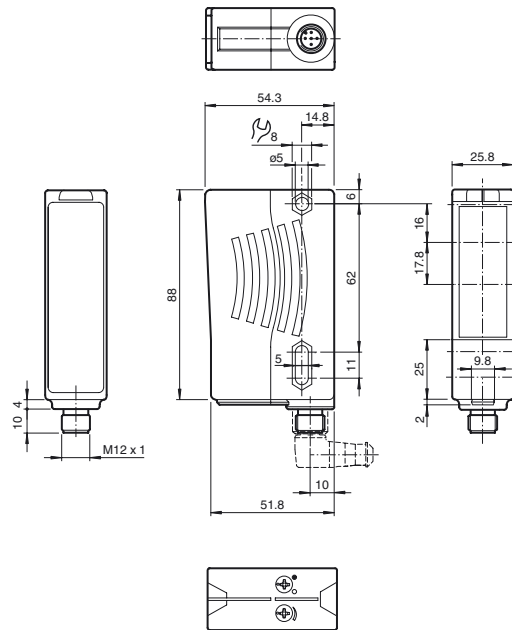

CLASS 1 LASER PRODUCT
IEC 60825-1:2007 certified.
Complies with 21 CFR 1040.10 and 1040.11 except for deviations pursuant to Laser Notice No. 50, dated June 24, 2007

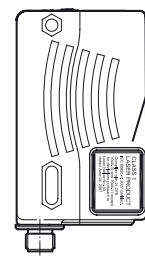

Electrical connection

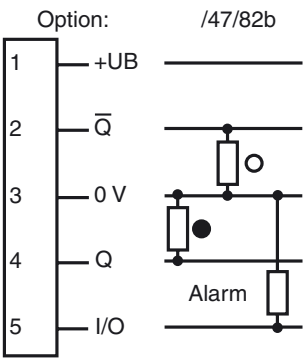

- = Light on
- = Dark on

Pinout

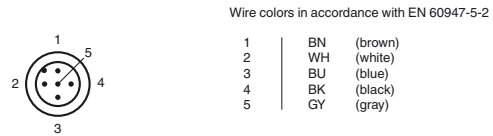

Indicators/operating means

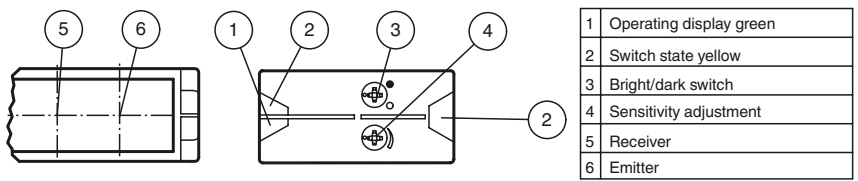

Release date: 2018-03-26 09:32 Date of issue: 2018-03-26 123760_eng.xml

Technical data**General specifications**

Effective detection range	0 ... 30 m
Reflector distance	0.3 ... 30 m
Threshold detection range	42 m
Reference target	MH82 reflector
Light source	laser diode
Light type	modulated visible red light
Polarization filter	yes
Laser nominal ratings	
Note	LASER LIGHT , DO NOT STARE INTO BEAM
Laser class	1
Wave length	650 nm
Beam divergence	< 1.5 mrad
Pulse length	approx. 4.5 μ s
Repetition rate	approx. 6 kHz ... 20 kHz
max. pulse energy	4 nJ
Diameter of the light spot	approx. 45 mm at 30 m
Angle of divergence	Emitter: < 0.1 ° Receiver: < 2 °
Ambient light limit	50000 Lux

Functional safety related parameters

MTTF _d	560 a
Mission Time (T _M)	20 a
Diagnostic Coverage (DC)	0 %

Indicators/operating means

Operation indicator	LED green
Function indicator	2 LEDs yellow, light up when light beam is free, flash when falling short of the stability control, off when light beam is interrupted
Control elements	sensitivity adjustment (Adjustment to < 25% of the effective operating range) , Light-on/dark-on changeover switch

Electrical specifications

Operating voltage	U _B	10 ... 30 V DC
Ripple		max. 10 %
No-load supply current	I ₀	≤ 35 mA
Protection class		II, rated insulation voltage ≤ 250 V AC with pollution degree 1-2 according to IEC 60664-1

Output

Pre-fault indication output	1 PNP, inactive when falling short of the stability control for 10;s immediately inactive if 4 light beam interruptions take place	
Switching type	light/dark on switchable	
Signal output	2 PNP, complementary, short-circuit protected, reverse polarity protected , open collectors	
Switching voltage	max. 30 V DC	
Switching current	max. 200 mA	
Voltage drop	U _d	≤ 2.5 V DC
Switching frequency	f	1000 Hz
Response time		0.5 ms

Conformity

Product standard	EN 60947-5-2
Laser safety	EN 60825-1

Ambient conditions

Ambient temperature	-10 ... 50 °C (14 ... 122 °F)
Storage temperature	-20 ... 75 °C (-4 ... 167 °F)

Mechanical specifications

Housing width	25.8 mm
Housing height	88 mm
Housing depth	54.3 mm
Degree of protection	IP67
Connection	5-pin, M12 x 1 plastic connector
Material	
Housing	Plastic ABS
Optical face	Plastic pane
Mass	80 g

Approvals and certificates

Protection class	II, rated voltage ≤ 250 V AC with pollution degree 1-2 according to IEC 60664-1
UL approval	E87056 , cULus Listed , class 2 power supply , type rating 1
FDA approval	IEC 60825-1:2007 Complies with 21 CFR 1040.10 and 1040.11 except for deviations pursuant to Laser Notice No. 50, dated June 24, 2007

Accessories**OMH-05**

Mounting aid for round steel \varnothing 12 mm or sheet 1.5 mm ... 3 mm

OMH-07

Mounting aid for round steel \varnothing 12 mm or sheet 1.5 mm ... 3 mm

OMH-21

Mounting bracket

OMH-22

Mounting bracket

OMH-MLV11-K

dove tail mounting clamp

OMH-RLK29-HW

Mounting bracket for rear wall mounting

OMH-RL28-C

Weld slag cover model

REF-MH82

Reflector with Micro-structure, rectangular 82 mm x 60 mm, mounting holes

Other suitable accessories can be found at www.pepperl-fuchs.com

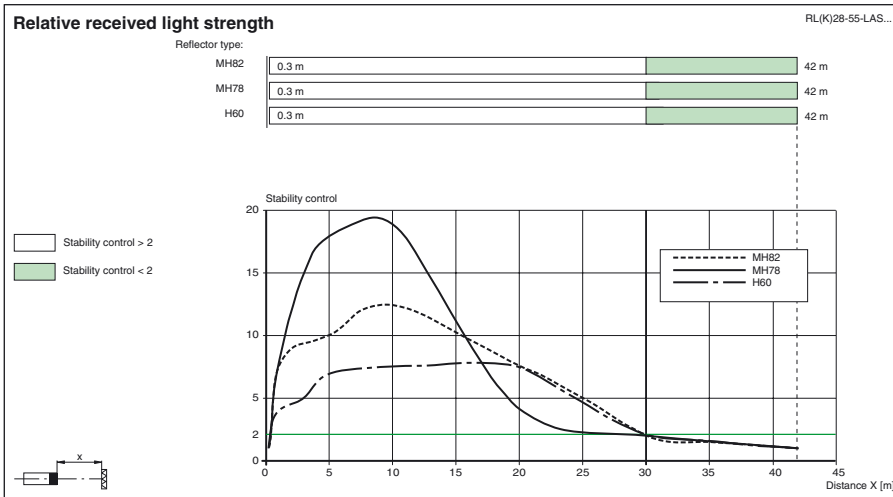

Curves/Diagrams

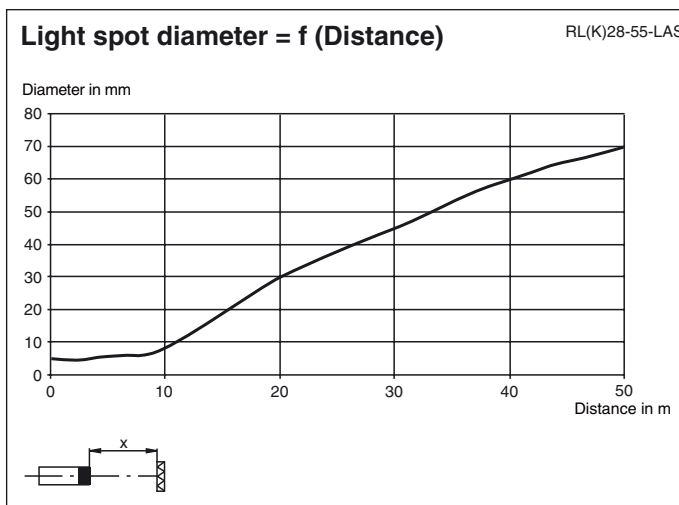

Laser notice laser class 1

- The irradiation can lead to irritation especially in a dark environment. Do not point at people!
- Maintenance and repairs should only be carried out by authorized service personnel!
- Attach the device so that the warning is clearly visible and readable.
- Caution – Use of controls or adjustments or performance of procedures other than those specified herein may result in hazardous radiation exposure.

Release date: 2018-03-26 09:32 Date of issue: 2018-03-26 123760_eng.xml

Refer to "General Notes Relating to Pepperl+Fuchs Product Information".