



Model Number

OBR12M-R101-2EP-IO-L

Laser retroreflective sensor with fixed cable

Features

- Miniature design with versatile mounting options
- DuraBeam Laser Sensors - durable and employable like an LED
- Extended temperature range -40°C ... 60°C
- High degree of protection IP69K
- IO-link interface for service and process data

Product information

The miniature optical sensors are the first devices of their kind to offer an end-to-end solution in a small single standard design — from thru-beam sensor through to a distance measurement device. As a result of this design, the sensors are able to perform practically all standard automation tasks.

The DuraBeam laser sensors are durable and can be used in the same way as a standard sensor.

The use of Multi Pixel Technology gives the standard sensors a high level of flexibility and enables them to adapt more effectively to their operating environment.

Dimensions

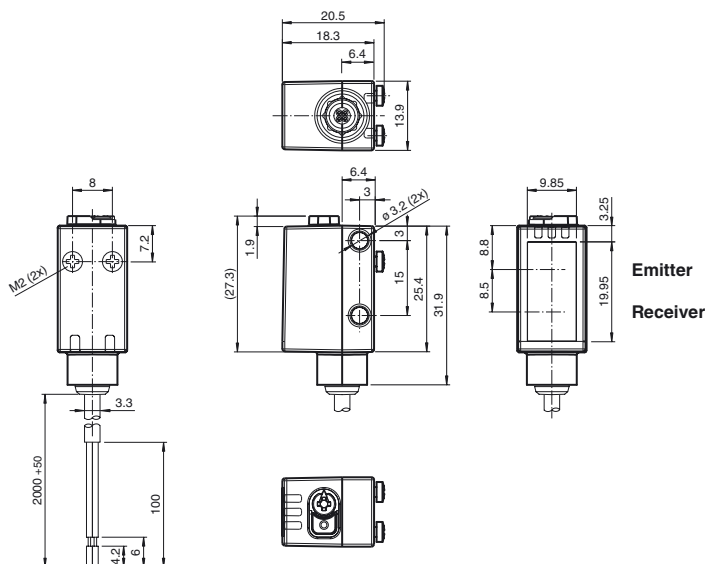

Electrical connection

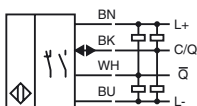

Indicators/operating means

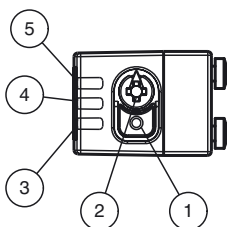

1	Light-on/dark-on changeover switch
2	Sensitivity adjuster
3	Operating indicator / dark on
4	Signal indicator
5	Operating indicator / light on

Release date: 2019-03-26 09:55 Date of issue: 2019-03-26 267075-100033_eng.xml

Technical data**General specifications**

Effective detection range	0 ... 12 m
Reflector distance	0.2 ... 12 m
Threshold detection range	15 m
Reference target	H50 reflector
Light source	laser diode
Light type	modulated visible red light
Polarization filter	yes
Laser nominal ratings	
Note	LASER LIGHT , DO NOT STARE INTO BEAM
Laser class	1
Wave length	680 nm
Beam divergence	> 5 mrad d63 < 2 mm in the range of 250 mm ... 750 mm
Pulse length	1.6 µs
Repetition rate	max. 17.6 kHz
max. pulse energy	9.6 nJ
Diameter of the light spot	approx. 30 mm at a distance of 12 m
Angle of divergence	approx. 0.3 °
Ambient light limit	EN 60947-5-2

Functional safety related parameters

MTTF _d	672 a
Mission Time (T _M)	20 a
Diagnostic Coverage (DC)	0 %

Indicators/operating means

Operation indicator	LED green: constantly on - power on flashing (4Hz) - short circuit flashing with short break (1 Hz) - IO-Link mode
Function indicator	Yellow LED: Permanently lit - light path clear Permanently off - object detected Flashing (4 Hz) - insufficient operating reserve
Control elements	Light-on/dark-on changeover switch
Control elements	sensitivity adjustment
Parameterization indicator	IO link communication: green LED goes out briefly (1 Hz)

Electrical specifications

Operating voltage	U _B	10 ... 30 V DC
Ripple		max. 10 %
No-load supply current	I ₀	< 20 mA at 24 V supply voltage
Protection class		III

Interface

Interface type	IO-Link (via C/Q = pin 4)
Transfer rate	COM 2 (38.4 kBaud)
IO-Link Revision	1.1
Min. cycle time	2.3 ms
Process data width	Process data input 2 Bit Process data output 2 Bit
SIO mode support	yes
Device ID	0x110202 (1114626)
Compatible master port type	A

Output

Switching type	The switching type of the sensor is adjustable. The default setting is: C/Q - BK: NPN normally open / dark-on, PNP normally closed / light-on, IO-Link /Q - WH: NPN normally closed / light-on, PNP normally open / dark-on	
Signal output	2 push-pull (4 in 1) outputs, short-circuit protected, reverse polarity protected, overvoltage protected	
Switching voltage	max. 30 V DC	
Switching current	max. 100 mA , resistive load	
Usage category	DC-12 and DC-13	
Voltage drop	U _d	≤ 1.5 V DC
Switching frequency	f	2000 Hz
Response time		250 µs

Conformity

Communication interface	IEC 61131-9
Product standard	EN 60947-5-2
Laser safety	EN 60825-1:2014

Ambient conditions

Ambient temperature	-40 ... 60 °C (-40 ... 140 °F) , fixed cable -25 ... 60 °C (-13 ... 140 °F) , movable cable not appropriate for conveyor chains
Storage temperature	-40 ... 70 °C (-40 ... 158 °F)

Mechanical specifications

Housing width	13.9 mm
---------------	---------

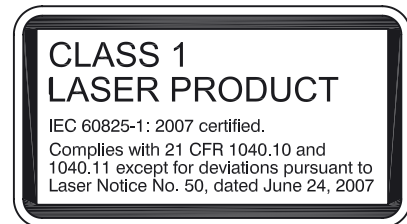
Laserlabel**Accessories****IO-Link-Master02-USB**

IO-Link master, supply via USB port or separate power supply, LED indicators, M12 plug for sensor connection

REF-MH50

Reflector with Micro-structure, rectangular 50.9 mm x 50.9 mm, mounting holes, fixing strap

OMH-R101

Mounting Clamp

OMH-R101-Front

Mounting Clamp

OMH-4.1

Mounting Clamp

OMH-ML6

Mounting bracket

OMH-ML6-U

Mounting bracket

OMH-ML6-Z

Mounting bracket

REF-MH82

Reflector with Micro-structure, rectangular 82 mm x 60 mm, mounting holes

REF-MH20

Reflector with Micro-structure, rectangular 32 mm x 20 mm, mounting holes

REF-MVR10

Reflector with Micro-structure, rectangular 60 mm x 19 mm, mounting holes

Other suitable accessories can be found at

Housing height	33.8 mm
Housing depth	18.3 mm
Degree of protection	IP67 / IP69 / IP69K
Connection	2 m fixed cable
Material	
Housing	PC (Polycarbonate)
Optical face	PMMA
Mass	approx. 36 g
Cable length	2 m

Approvals and certificates

UL approval	E87056 , cULus Listed , class 2 power supply , type rating 1
FDA approval	IEC 60825-1:2007 Complies with 21 CFR 1040.10 and 1040.11 except for deviations pursuant to Laser Notice No. 50, dated June 24, 2007

Curves/Diagrams

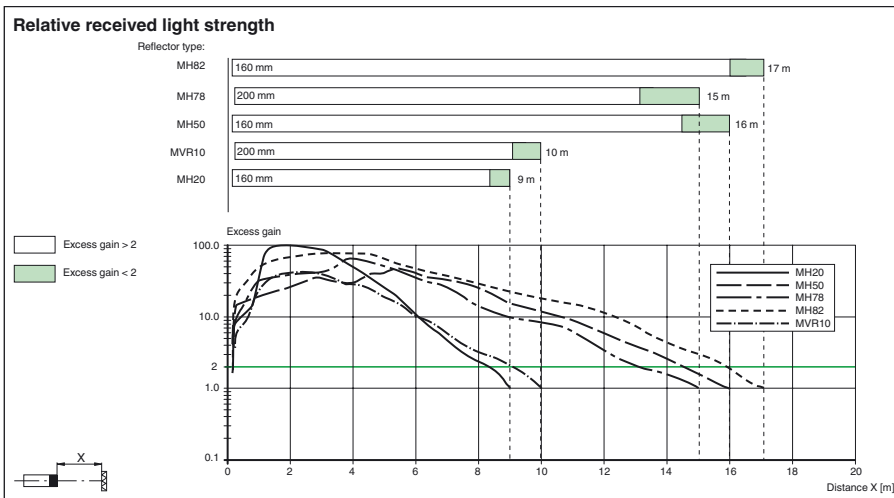
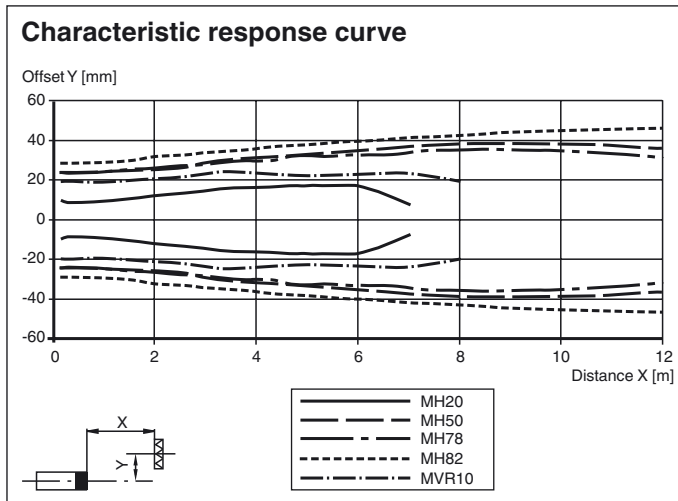

Functions and Operation

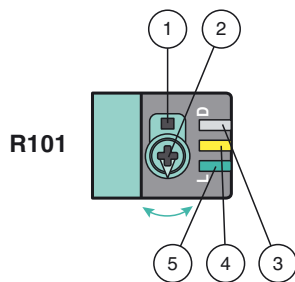

- 1 - Light-on / dark-on changeover switch
- 2 - Sensing range /sensitivity adjuster
- 3 - Operating indicator / dark on
- 4 - Signal indicator
- 5 - Operating indicator / light on

To unlock the adjustment functions turn the sensing range adjuster for more than 180 degrees.

Sensing Range / Sensitivity

Turn sensing range / sensivity adjuster clockwise to increase sensing range / sensitivity.

Release date: 2019-03-26 09:55 Date of issue: 2019-03-26 267075-100033_eng.xml

Refer to "General Notes Relating to Pepperl+Fuchs Product Information".

Turn sensing range /sensitivity adjuster counter clockwise to decrease sensing range / sensitivity.

If the end of the adjustment range is reached, the signal indicator starts flashing with 8 Hz.

Light-on / Dark-on Configuration

Press the light-on / dark-on changeover switch for more than 1 second (less than 4 seconds). The light-on / dark-on mode changes and the operating indicators are activated accordingly.

If you press the light-on / dark-on changeover switch for more than 4 seconds, the light-on / dark-on mode changes back to the original setting. On release of the light-on / dark-on changeover switch the current state is activated.

Restore Factory Settings

Press the light-on / dark-on changeover switch for more than 10 seconds (less than 30 seconds) until all LEDs turn off. On release of the light-on / dark-on changeover switch the signal indicator turns on. After 5 seconds the sensor resumes operation with factory default settings.

After 5 minutes of inactivity the sensing range / sensitivity adjustment is locked. In order to reactivate the sensing range /sensitivity adjustment, turn the sensing range / sensitivity adjuster for more than 180 degrees.